

2026

Arnold Pool Company



Ogallala, Nebraska

1801 Stagecoach Trail • Ogallala, NE 69153

SWIMMING POOL & SPA EQUIPMENT & SUPPLIES

to place orders

Phone: (308) 284-4754

1-800-652-6615

e-mail: info@arnoldpoolcompany.com

Find us on 

Shop our catalog on-line at: www.arnoldpoolcompany.com

INDEX

Above-Ground Pool Equipment . . .	18, 20, 25	Liners, Vinyl	17
Above-Ground Pool Liners	17	Maintenance	12, 13, 25, 40
ACID Magic	3, 16	Mineral Springs Pool Care System	7
Algicides	3, 6	Ozonators	40
Automatic Chlorine/Bromine Feeders	8	Paint & Stain	16
Automatic Pool Covers	30	Patch Kits, Vinyl	17
Backwash Hose	13	Poles, Handles & Hangers	12
Baskets, Check Baskets, Pins & Access.	36	Pool Cleaners	25
Baskets, Pump & Skimmer	26	Pumps	20, 21, 25, 31
Bromine Feeders	8	Racing Lane Lines	36
Bromine	3, 4, 39	Reagents & Test Kits	9
Brushes	13	Reels, Solar Cover	28, 29
Caulking	16	Rescue Tubes & Equipment	15
Chemicals	3, 4, 5, 6, 7, 9, 10, 11, 39, 40	Ring Buoys	15
Chemical Maintenance Instructions	2, 41	Rope, Floats & Hooks	14
Chlorine	3, 4, 5, 39	Safety Equipment	15
Chlorine Feeders	8	Sand, Filter	3
Chlorinator Replacement Parts	8	Scumballs	40
Clocks	14	Shocks	6
Commercial Chemicals	3, 5, 6, 7, 9, 10, 11	Shower Curtains	36
Comm. Facility Equip.	12-16, 18-29, 32-37	Sight Glasses	25
Covers, Pool & Spa	28, 29, 30, 31	Signs	37
Deck Stain (Duckback)	16	SilkGuard Chlorinating Pool Products	4, 5
Deck Surfacing	16	Skim Mor Filter Sock	5, 11
Depth Markers	15	Skimmers & Baskets	26, 27
Diatomaceous Earth Filter Powder	3	Slides/Slide Spray Repair Kit	34
DE Filter Elements & Covers	23	Soda Ash	3
Diving Boards	34	SoftSwim Pool Care System	7
Diving Board Refinishing Kit	16	Solar Blankets	28
Drain Covers – <i>Virginia Graeme-Baker</i>	27	Solar Heat	18
Exercise Tethers	36	Spa Care Instructions	41
Filters & Valves	22, 23, 24, 38	Spa Cartridge Filters	24, 38
Filter Sand & DE Powder	3	Spa Chemicals & Accessories	39, 40
Floats, Rope	14	Spa Covers	28, 29, 40
Flooring	36	Spa Heaters	18
Flow Meters	25	Spa Section	38, 39, 40, 41
Games & Toys	17	Spa System Flush	39
Gauges	25	Spa Vacuums	40
Goggles	17	Spine Boards	15
Hand Rails	33, 35, 40	Stabilizers/Conditioners	3, 10
Handicap Pool & Spa Lifts	35	Test Kits & Reagents	9
Heaters	18, 19	Thermometers	14, 40
Heat Sinks	19	Umbrellas, Lifeguard	34
Kick Boards	17, 36	Vacuum Carts, Portable	25
Ladders & Handrails	32, 33, 35, 40	Vacuum Heads & Hose	12, 13
Leaf Skimmers & Rakes	13	Vinyl Liners & Patch Kits	17
Life Hooks	15	Wall Anchors for Rope	14
Life Vests, USCG Approved	15	Water Tubes	31
Lifeguard Accessories	15, 34, 36	Waterite DE Filter Elements	23
Lifeguard Chairs	34	Whistles & Lanyards	36
Lights, Bulbs, Lens, Gaskets	27	Winter Covers & Accessories	30, 31

ARNOLD POOL COMPANY

www.arnoldpoolcompany.com

info@arnoldpoolcompany.com

1801 Stagecoach Trail

Ogallala, NE 69153

308-284-4754

800-652-6615

Store Hours:

9:00 a.m. to 4:30 p.m. (MT) Monday-Friday

We at Arnold Pool Company are here to serve **YOU!!!** Our mission is to enhance your pool and spa experience so that you may enjoy a healthier and happier life. This catalog is representative of swimming pool and spa supplies and parts available today, but it is by no means a complete listing. If you need something, **we will try our best to get it for you!!!**

OUR GOAL IS YOUR SATISFACTION!!!

TO PLACE AN ORDER:

Be prepared to give:

1. Name of purchaser (and your name, if different).
2. Shipping address **and** billing address.
3. Phone number of purchaser.
4. If purchaser does not have an established charge account with us:
MC/VISA card name, number and expiration date.
5. Description of items to be ordered:
 - A. Product Number and Name, Quantity and Size.
 - B. On PARTS: model number of equipment, part name and ANY CLUES are helpful.

Call in your order by 11:00 AM to receive same-day shipment! We have been known to work miracles, but, **PLEASE**, do try and **PLAN AHEAD**. When items ordered are not available, we reserve the right to make substitutions equal in quality.

Our catalog pricing is good for the year, subject to manufacturer's price increases that may occur after printing. On larger items, you may wish to confirm freight charges.

WE WILL GLADLY GIVE PRICE QUOTATIONS OR BIDS.

Merchandise returned for credit will not be received without our written approval. If merchandise was ordered in error by customer, we reserve the right to make a 20% restocking charge. Special orders cannot be returned. Returns must be made **within 30 days** for any credit.

All merchandise is covered by the manufacturer's warranty only.

Credit Customers: Accounts are due the 15th of the month following purchase.

Past Due Accounts are assessed a late fee of 1.5% per month.

All merchandise shipped by common carrier is at buyer's risk. Seller's responsibility ceases with receipt of bill of lading from the common carrier. We may, if requested, insure goods for the buyer.

Maintaining Your Pool



1 Kill bacteria continuously.

BioGuard stabilized chlorine provides 24-hour-a-day bacterial killing power to control possible cross-infection of swimmers. It won't be destroyed by sunlight. Depend on it! Available in **SilkGuard Complete Sticks, 1" or 3" Tablets or granular form** – for automatic or manual addition to the pool. See pages 4 and 5.

STEP 1

2 Remove swimmer wastes.

"SHOCK"

BURN OUT 3

OR

SMART SHOCK



Every 2 weeks
(weekly for commercial pools)

Every week

Use at sundown to treat your pool for a sparkling result the next day.

Special oxidizer-clarifier formula to restore sparkle to your pool.

STEP 2

Restore sparkle to your pool with a BioGuard **Oxidizing** treatment. Swimmer wastes like urine, perspiration, suntan oil and hair sprays accumulate as a pool is used. They make eyes sting, irritate skin, dull water and give algae plenty of food to feast on. Wastes weaken powerful chlorines, so you may be using more and more chlorine to no avail. Step 2 is important!!! See page 6.



3 Prevent algae growth.

Prevent algae growth with BioGuard **Algae Complete**. It pays to prevent algae from ever getting a start. Used the morning after a **Step 2 treatment**, it works WITH your BioGuard chlorine – they complement each other. If algae already has a start, you can nip the problem in the bud with BioGuard's exclusive family of algicides.

Algae can ruin your pool's health and looks, clog your filter, and make your pool walls slippery and unsafe. It costs plenty to cure and just pennies to prevent! See page 6.

STEP 3

Commercial Products

WE WILL GLADLY GIVE BIDS! CALL US.



PROGUARD 1" TABLETS 90% Available Chlorine
Page 5 50# Bucket, 10 or more \$319.50

PROGUARD 3" TABLETS 90% Available Chlorine
Page 5 50# Bucket 365.99

SUPER SOLUBLE granular 62% Available Chlorine
BG-52203 25# Bucket 262.95

BROMINATING TABLETS
BPG-22036 50# Bucket 465.00

CALCIUM HYPOCHLORITE granular

CLC CLASSIC-FULL STRENGTH 68% ACTIVE FORMULATION
Page 5 25# Bucket \$ 180.00

STABILIZER (Conditioner) 100% Cyanuric Acid
Page 10 40# Bucket \$195.00

ALGAE COMPLETE Commercial Algae Inhibitor
Page 6 2 L. Bottle 69.50

POLYSHEEN BLUE (Water Clarifier)
Page 11 Quart (treats 160,000 gal.) 26.99

DIATOMACEOUS EARTH FILTER POWDER, 25# Bag
BLK-DE25 Per Bag \$ 27.00

FILTER SAND, 50# Bag, 20 grit
BLK-SAND50 Per Bag 23.50

SODA ASH, 50# Bag
BLK-ASH50 Per Bag \$ 44.00

ACID MAGIC (Buffered Muriatic Acid)
CER-ASA/128-1 Gallon 21.95
CER-ASA/15G-1 15 Gallon Drum (no deposit) 245.00



BioGuard
Authorized Pool & Spa Care Center





Brominating Tablets

Brominating tablets provide continuous treatment when applied through a bromine feeder. Bromine is not able to be stabilized, so it is best suited as an alternative sanitizer for automatic feeders in indoor applications. 92.5% active ingredients.

BG-22034	25# Bucket	\$272.99
BPG-22036	50# Bucket	465.00



Granular Chlorine

100% Sodium Dichloro-S-Triazinetrione
62% Available Chlorine

SUPER SOLUBLE

Dichloro granular chlorine dissolves instantly, killing bacteria without upsetting pH balance. Easy to use with all pools – add directly to pool water or through hypochlorinators.

BG-21049	5# Bucket	\$ 66.50
BG-52203	25# Bucket	262.95



Chlorine SilkGuard Complete

91.57% Trichloro-s-triazinetriene
84% Available Chlorine

Chlorine Tabs and Sticks that work 24 hours/day, continually releasing stabilized chlorine. Prevents staining and corrosion reduces scale and softens water making the water SILKY smooth. Greater algae prevention with algae-killing crystals. ALL pool types, with ALL pumps and in ALL applications. Wonderfully simple!!!

SILKGUARD COMPLETE TABS

1" SILKGUARD COMPLETE TABS

BG-52370	4.5# Bottle	\$ 63.50
----------	-----------------------	----------

3" SILKGUARD COMPLETE TABS

BG-52360	3.5# Bottle	\$ 49.99
BG-52362	7.5# Bottle	99.99
BG-52366	25# Bucket	221.99



Authorized Pool
& Spa Care Center



SilkGuard Complete Sticks

91.57% Trichloro-s-triazinetriene
84% Available Chlorine

BG-52350	4# Bottle.....	\$ 59.99
BG-52354	18# Bucket.....	184.00

Chlorine Tabs

99% Trichloro-s-triazinetriene
90% Available Chlorine

PROGUARD 1" TABS

Ideal for Chlorinators. No gummy binders to clog equipment.

BPG-21654	50# Bucket.....	\$339.50
-----------	-----------------	----------

PROGUARD 3" TABS

Great for skimmers and floaters.

BPG-21785	50# Bucket.....	365.99
-----------	-----------------	--------



SKIM MOR FILTER AID

Disposable filter sock. Use in the skimmer basket on top of Sticks or Tabs to catch debris.

BG-21401	Skim Mor Filter Sock	\$ 23.50
----------	--------------------------------	----------

CALCIUM HYPOCHLORITE

**CLC CLASSIC-FULL STRENGTH 68%
ACTIVE FORMULATION**

SCP-25246	25# Bucket.....	\$ 180.00
-----------	-----------------	-----------



BioGuard®
Guarding more than your pool.

Shocks - Step 2



BURN OUT 3

Shock – Clarify – Oxidize all in one! Use every two weeks, 1# per 10,000 gallons of water.

BG-22808BX 12# Box (12-1# bags) .. \$ 124.99
 BG-22808BG 1# Bag 10.50

SMART SHOCK

Special oxidizer/clarifier product used weekly. Use 1# per 12,000 gallons of water.

BG-22947BX 12# Box(12-1# bags) ... \$126.00
 BG-22947BG 1# Bag 10.99
 BG-52728 25# Bucket 225.99

OXYSHEEN

Destroys swimmer wastes without chlorine so swimming can resume almost immediately.

BG-22841BX 12# Box (12-1# bags) .. \$ 122.99
 BG-22841BG 1# Bag 10.99
 BPG-22846 50# Bucket 309.00



Algicides - Step 3



ALGAE COMPLETE

Dual active ingredients combine traditional quat-based algicide and chelated copper in one powerful, high performance product.

BG-25766 2 L. Bottle \$ 69.50

BACK UP 2

Broad spectrum formula that inhibits and kills algae.

BG-23050 Quart \$ 33.25

ALGAE ALL 60

Non-foaming algicide. Ideal for pools with attached spas or fountains.

BG-23060 Quart \$ 46.95

BANISH

Specially formulated copper-based algae killer.

BG-23500 Quart \$ 45.50

SPOT KILL ALGAE DESTROYER

Kills green and black algae.

BG-23107 2# Bottle \$ 23.99

SoftSwim Sanitizing System

The **SoftSwim** Maintenance Program is a great chlorine alternative that leaves the water soft and silky. SoftSwim A, B, and C are all easy to apply liquid products – no predissolving and no mess.

SOFTSWIM ‘A’

SoftSwim Algicide is used to prevent algae growth. It penetrates the tiny cracks and pores of the pool surface, where algae can start. Use 2 oz. per 5,000 gallons of water every other week.

BG-22853 Quart \$ 39.25

SOFTSWIM ‘B’

SoftSwim B is used to sanitize the water and control bacteria.

BG-22852 ½ Gallon \$ 49.50

SOFTSWIM ‘C’

SoftSwim C is used to remove undesirable compounds and keep the water sparkling. Use 1 gallon per 10,000 gallons of water, once a month.

BG-22851 Gallon \$ 23.99



SOFTSWIM FILTER AID-FLOCCULANT

BG-22854 1# Bottle \$ 14.99

SOFTSWIM FILTER CLEANER

BG-22859 Quart \$ 26.50

SOFTSWIM STAIN CONTROL

BG-23457 Quart \$ 27.50

Mineral Springs Sanitizing System

The **Mineral Springs** Maintenance Program takes natural minerals and produces sanitizer through a process called electrolysis (the conversion of minerals to free available chlorine). This is how sanitizer is naturally generated. It's a natural, convenient way to generate sanitizer for your pool water, resulting in *fantastically silky, dazzling water*.

MINERAL SPRINGS SYSTEM

Saline Chlorination Sanitizing System

Unit \$2,950.00

BEGINNINGS

Provides minerals to allow unit to create sanitizer, prevents scaling and softens water.

BG-23540 27.9# Bucket \$ 53.50

RENEWAL

Replenishes minerals, keeps pH stable, clarifies, prevents scaling and softens water.

BG-23541 16# Box (4 - 4# Bottles) .. \$87.00

STAIN & SCALE

Protects against scale formation and scale build up.

BG-23245 Quart \$ 31.50

CELL CLEANER

Effectively and efficiently cleans any chlorine generator cell.

BG-23242 Quart \$ 22.00

Chlorine/Bromine Feeders

AUTOMATIC CHLORINE/BROMINE FEEDERS

24-hour a day sanitizing made easy. No special venting required. Completely enclosed, no escaping gases. Positive external no-clog control valve. No equipment damage. Feeds sanitizer directly to pool.

RB-171215	97,600	20,200	\$339.95
RB-171230	160,000	40,000	369.95
RB-171240	332,000	61,000	389.95

CHLORINE/BROMINE FEEDER REPLACEMENT PARTS

RB-172214	Lock Ring	\$ 37.50
RB-172385D	Lid Assembly	46.50
RB-172224XZ	Air Vent Valve	9.50
RB-172221Z	O-Ring Vent Valve	3.95
RB-172240	O-Ring Lid to Housing	19.50
RB-172375	Lock Screw	2.95
RB-172374	Lock Spring	8.95
RB-175251	Screen	10.95
RB-172435	Check Ball	15.95
RB-270484	Closed Nipple, 1"	9.50
RB-270531	Threaded Union, 1"	29.95
RB-172439	Control Valve	124.95
RB-172036	Silicone Lubricant	14.95
RB-175009	Hose Bib with Handle, 1/2"	28.95
RB-172134	Threaded Plug, 1/2"	10.50
RB-172082	Flow Indicator	279.95

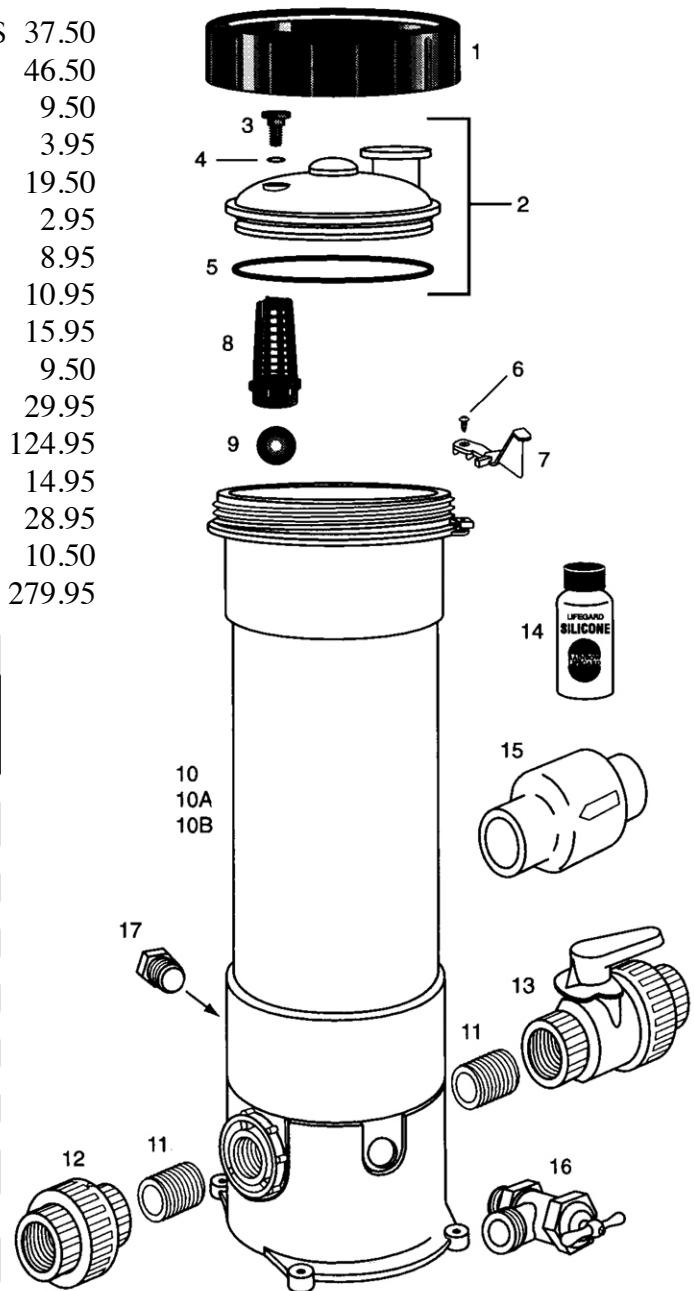

REMEMBER:

Chlorine/Bromine Feeders are designed to use BIOGUARD Silk Sticks or Tabgard 1" tablets **ONLY**. Use of improper chemicals may cause fire and/or explosion. Calcium Hypochlorite is **NOT** to be used in any form.

DO NOT MIX CHEMICALS!!!

Item	Qty.	Part No.	Description
Order No.: R171215, R171230, R171240			
Model No.: HC-3315, HC-3330, HC-3340			
Description: HIGH CAPACITY AUTOMATIC FEEDER			
1	1	R172214	Lock ring
2	1	R172385D	Lid assembly complete
3	1	R172224X	Vent valve
4	1	R172221	O-ring vent valve
5	1	R172240	O-ring lid to housing
6	1	R172375	Lock screw
7	1	R172374	Lock spring
8	1	R175251	Screen
8A	1	R171919	Check Valve Seat
9	1	R172435	Check ball
11	2	R270484	1 in. Close nipple
12	1	R270531	1 in. Threaded union
13	1	R172439	Control valve
14	1	R172036	Silicone lubricant, 3/4 oz.
15	Opt.	R172288	1-1/2 in.-2 in. Check valve
16	1	R175009	Hose Bib w/t Handle 1/2 in.
17	1	R172134	1/2 in. threaded plug
NOT SHOWN			
		R172082	Flow rate indicator

Water Analysis – Test Kits

BIOGUARD TEST KITS/REAGENTS

HOME MODEL-1200V TEST KIT

Performs 5 basic tests: (1) free chlorine, (2) pH, (3) acid demand, (4) alkali demand, (5) total alkalinity.

BG-26130 1200V Test Kit \$ 59.50

TEST BODIES/REAGENTS

BG-26226	DPD #1 Tabs, pack of 50	\$ 12.99
BG-26228	DPD #3 Tabs, pack of 50	11.75
BG-26230	DPD #4 Tabs, pack of 50	12.99
BG-26240	Reagent #1, OTO	5.55
BG-26242	Reagent #2, Phenol Red	5.55
BG-26244	Reagent #3, Acid Demand	5.55
BG-26250	Reagent #3B, Alkali Demand	5.55
BG-26246	Reagent #4, Chlorine Neutralizer	5.55
BG-26248	Reagent #5, Methyl Orange	5.55
BG-26232	Calcium Hardness Tabs, pk of 20	8.75
BG-26236	Cyanuric Acid Tabs, pk of 50	20.65
BG-26220	Copper Test Tablets, pk of 96	111.65



**Computerized
Water Analysis**

TAYLOR TEST KITS/REAGENTS

FAS-DPD CHLORINE TEST KIT

Performs 8 tests: (1) free chlorine, (2) total chlorine, (3) pH, (4) acid demand, (5) alkali demand, (6) total alkalinity, (7) cyanuric acid (stabilizer) and (8) calcium hardness.

TAY-K-2006 FAS-DPD Test Kit \$ 123.95

ALSO AVAILABLE IN A BROMINE TEST KIT!

TEST BODIES/REAGENTS

TAY-9058	Taylor Test Body	\$ 16.95
TAY-R-0001-A	DPD #1, 22ml	7.50
TAY-R-0001-C	DPD #1, 60ml	13.95
TAY-R-0002-C	DPD #2, 60ml	13.95
TAY-R-0003-C	DPD #3, 60ml	13.95
TAY-R-0004-C	pH Indicator, 60ml	10.50
TAY-R-0870-I	DPD Powder, 10 gr	12.95
TAY-R-0871-A	Cl Titrating Sol., 22ml	14.95
TAY-R-0871-C	Cl Titrating Sol., 60ml	17.50
TAY-R-0872-C	Br Titrating Sol., 60ml	17.50
TAY-R-1003J-C	Phenol Red, 60ml	10.95

OTHER TAYLOR REAGENTS ALSO AVAILABLE!



Balancers



STABILIZERS & pH ADJUSTERS:

STABILIZER 100 100% Cyanuric Acid
 "Holds" chlorine in the water to prevent its loss to the sun. Use 1# per 3000 gallons to reach the recommended 40ppm level.

BG-23481 5# Bag 45.99
 BPG-23249 40# Bucket 195.00

INSTANT STABILIZER 100 Liquid
 1 gallon will raise levels by 32 ppm per 10,000 gal.

BG-23217 Gallon \$ 56.50

LO'N SLO

Safe, dry acid to lower pH in pool water.

BG-23477 8# Bag 21.50

BALANCE PAK 200

Raises pool water pH.

BG-23469 6# Bag 24.50

MINERAL & METAL ADJUSTERS:

POOL MAGNET PLUS

Chelating agent that prevents stains from iron, copper and manganese from forming on pool walls. To remove metals, use with Sparkle Up.

BG-23454 Quart \$ 29.00

SCALE INHIBITOR

Controls excess calcium in pool water to prevent scale deposits.

BG-23902 Quart \$ 29.00

BALANCE PAK 100

Raises Total Alkalinity in pool water.

BG-23461 5# Bag \$ 15.99
 BG-23463 12# Bag 32.99
 BPG-23415 25# Bucket 52.99

BALANCE PAK 300

Raises Calcium Hardness in pool water.

BG-23471 7# Bag \$ 20.99
 BG-52220 12# Bucket 32.50

ERASE IRON STAIN REMOVER

Removes iron stains.

BG-23733 2# Bottle \$ 53.50



Authorized Pool
 & Spa Care Center

Accessory Chemicals



WATER ENHANCERS:

POLYSHEEN BLUE CLARIFIER

Add directly to pool water with filter operating to restore sparkle. Combines small particles into larger masses so the filter can catch them better. Excellent for weekly maintenance.

BG-23721 Quart \$26.99

SPARKLE UP

Increases sand and DE filter efficiency by trapping smaller particles. Also removes metals from the water. Easy to use.

BG-23715 1.5# Bottle \$38.75

NATURAL CLARIFIER

Fine sediment particles bind together to make big particles that are removed by your filter.

BG-23742 Quart \$26.25

ECOKLEAN

100% biodegradable cellulose fiber. Alternative to DE for a diamond-like sparkle to your pool.

BG-23759 3# Bag \$23.75

POOL COMPLETE WEEKLY

3-in-1 high intensity clarifier and cleaner adds the final touch to any pool program.

BG-25767 Gallon \$71.00

OPTIMIZER PLUS

Saves money by increasing the efficiency of ANY chemical program. Adds sparkle, too!

BG-23770 8# Bucket \$ 42.50

BG-23772 20# Bucket 102.00

CLEANERS / MISCELLANEOUS:

OFF THE WALL SURFACE CLEANER

Compatible with pool water. Acidic composition makes it great for SCALE buildup and tile line "bathtub ring".

BG-23613 Pint \$12.50

STRIP KWIK FILTER DEGREASER

Removes suntan oil and GREASE from sand, DE and cartridge filters. Promotes filter efficiency.

BG-23756 Quart \$23.00

KLEEN-IT FILTER CLEANER

Removes SCALE and stains from sand, DE and cartridge filters. A must for hard water areas.

BG-23758 Quart \$24.99

CHEM-OUT

Chlorine neutralizer for treating pools where chlorine level is too high.

BG-23647 2# Bottle \$33.25

ANTIFOAM

BG-23642 Quart \$29.50

STOWAWAY

Cleaner and deodorizer for preparing covers for storage.

BG-23650 Quart \$26.99

Maintenance

POLES AND ACCESSORIES

PS-176	Aluminum Telescopic 4' x 8' pole	\$ 75.50
PS-133	Aluminum Telescopic 6' x 12' pole	79.95
PS-132	Aluminum Telescopic 8' x 16' pole	149.95
RB-806-24	Aluminum Telescopic 12' x 24' pole	204.95
RB-820-12	Aluminum Seamless 12' pole	144.95
RB-820-16	Aluminum Seamless 16' pole	171.50
PS-091	E-Z Lock Telepole Cam.	15.95
PS-047	Snap-Adapt Handle	14.50
PS-039	Kwik-Snap Spring (#3 of RB-250 - pack of 3)	12.95
PM-36621	Brass bolts with wing nuts (pair)	12.95
PS-079	Pole Hanger, Aluminum	19.95
PM-35610	Jumbo Hose Hanger.	23.95

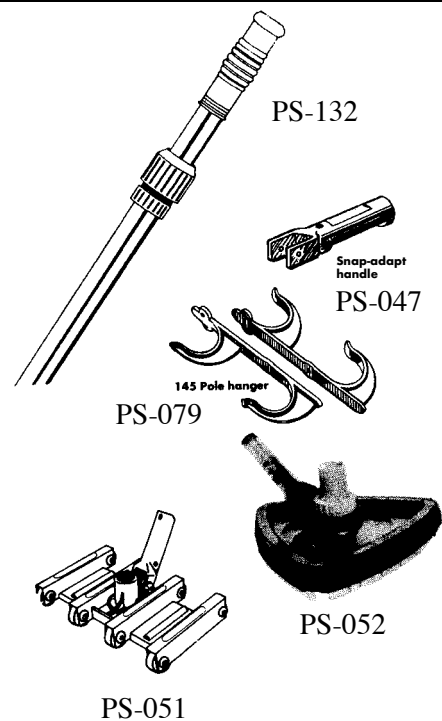

VACUUM HEADS-CONCRETE POOLS

PS-051	14" Flexible Vacuum, 1-1/2" Vac Hose	\$ 56.50
PS-878	19" Jumbo Flexible Vac., 1-1/2" Vac Hose	99.50
RB-250	19" Swivel Wheel Commercial, 1-1/2" / 2" Hose	155.45
PS-994	22" Professional Series Flexible Vac Head	364.50
GLF-80-805-190	Fairlocks Vac Head, Commercial, 1-1/2" / 2"	399.95

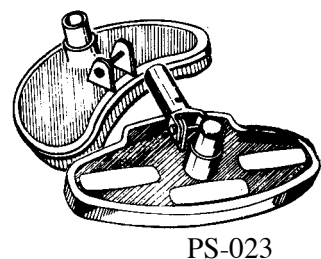

VACUUM HEADS-VINYL POOLS (Spa Vacs--see page 40)

PS-023	Vinyl Vacuum, 1-1/4" or 1-1/2" Vac Hose	38.95
PS-048	Econo Triangle Vacuum, 1-1/4" or 1-1/2" Vac Hose	38.95
PS-052	Triangle Vacuum, Clear-View, 1-1/4" or 1-1/2"	66.50

LEAF TRAPS AND BAGGERS

RB-185	Leaf Trap, fits on vac hose	\$ 77.50
JAN-1142	Wheel Leaf Bagger /Concrete use w/ garden hose	78.95
PS-409	Deluxe Series Leaf Eater w/wheels.	79.95

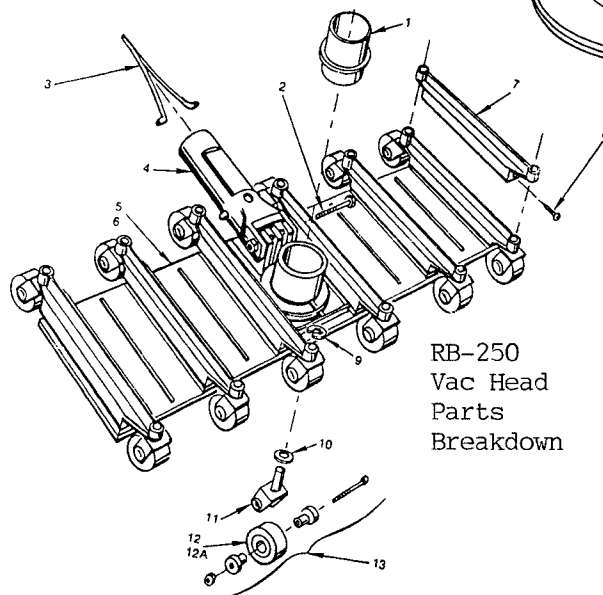
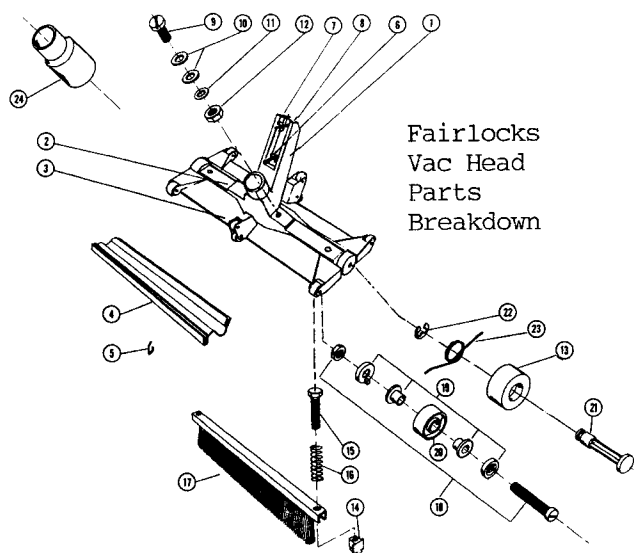
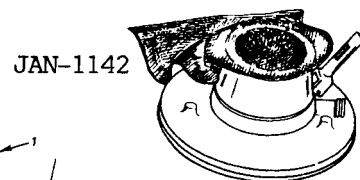

Maintenance

LEAF SKIMMERS AND RAKES (Have snap-adapt for telepoles)

PS-043	Leaf Rake with Handle	\$ 27.50
PS-087	Aluminum Frame Leaf Skimmer	23.95
PS-871	Heavy Duty Leaf Skimmer	52.95
PS-7081	Heavy Duty Leaf Skimmer Net Replacement	36.95
PS-160	Aluminum Frame Leaf Rake	50.95
RB-117	Pro Leaf Rake	77.50
RB-117R	Pro Leaf Rake Replacement Frame & Net	56.50
PS-146	Leaf Skimmer with Telescopic Pole	23.50

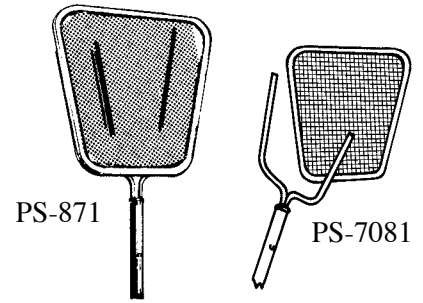

BRUSHES AND CLEANERS

PS-025	18" Curved Wallbrush w/ snap-adapt	\$ 29.95
PS-077	Multipurpose Hand Scrubber	14.95
PS-166CB	18" Curved Wallbrush for Vinyl Pools w/ snap-adapt	18.95
PS-495	24" Curved Wallbrush w/ snap adapt	73.50
RB-712	12" S/S Algae Brush w/ snap adapt	47.50
RB-651	Universal Scrubber with snap adapt	49.95
RB-651R	Replacement Pad:	15.50
	Light (white), Medium (blue) or Heavy (brown)	
RB-111584	3" x 10" Wood Deck Brush (Acid Washing)	21.50
RB-618	Wooden Handle for Deck Brush	16.50

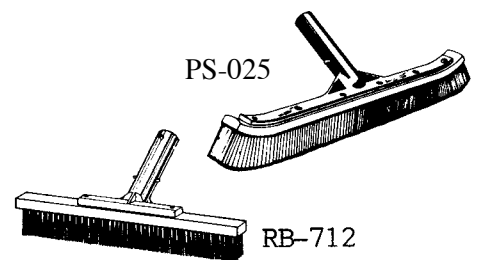

VACUUM HOSE & BACKWASH (DISCHARGE) HOSE

BG-25918	30' x 1-1/4" Vacuum Hose	\$ 53.95
BG-25920	35' x 1-1/4" Vacuum Hose	61.95
BG-25922	40' x 1-1/2" Deluxe Vac Hose, Swivel Cuff	84.75
BG-25926	50' x 1-1/2" Deluxe Vac Hose, Swivel Cuff	98.50
PS-584	50' x 2" Heavy Duty Vac Hose	329.50
ALA-211	1-1/2" Vac Hose Cuff	12.95
ALA-212	1-1/2" Vac Hose Coupler/Mender	14.95
ALA-231	2" Vac Hose Cuff	15.00
ALA-232	2" Vac Hose Coupler/Mender	17.50
ALA-241	1-1/4" Vac Hose Cuff	9.95
ALA-242	1-1/4" Vac Hose Coupler/Mender	12.95
RB-221222	1-1/2" .030 Wall, Blue Vinyl BW Hose, per ft.	1.00
RB-221224	2" .030 Wall, Blue Vinyl BW Hose, per ft.	1.38



RB-111584
w/RB-618

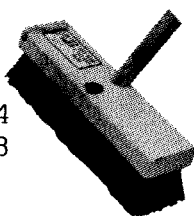

651

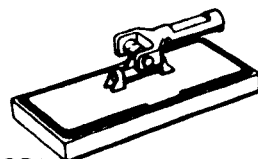

PS-077

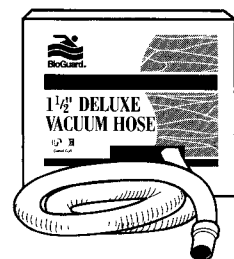
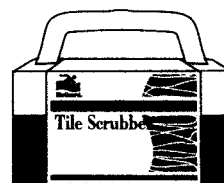

BG-25922

Rope, Floats, Thermometers & Clocks

POLYETHELENE ROPE AND PLASTIC FLOATS

AMG-PR25	1/4" Rope, Blue/White, Twisted, per foot	\$.35
AMG-PR50	1/2" Rope, Blue/White, Twisted, per foot60
AMG-PR75	3/4" Rope, Blue/White, Twisted, per foot95
PS-689	3" x 5" Float, fits 1/2" rope	8.95
PS-688	5" x 9" Float, fits 3/4" rope	9.95
RB-72	#590 Float Keepers for 1/2" rope, pair	5.75
RB-74	#590 Float Keepers for 3/4" rope, pair	5.75
AMG-5950	5" x 9" Twist-Locking Float, fits 1/2" rope	14.95
AMG-5975	5" x 9" Twist-Locking Float, fits 3/4" rope	14.95

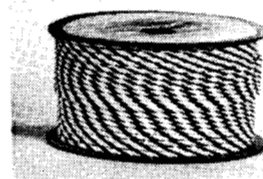

ROPE



AMG-5950

ROPE HOOKS

PER-PH-52	1/2" Bar Clamp Loop Style	\$ 23.75
PER-PH-53	3/4" Bar Clamp Loop Style	29.95
HAY-SP-47	3/4" Rope Clamp	30.95

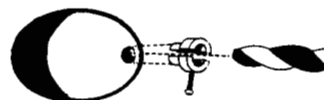

PS-688 RB-72

WALL ANCHORS

SRS-A41141	C/P Bronze Cup with Removeable Eyebolt	\$219.95
SRS-A41156	C/P Bolt with Lead Expansion Eyebolt	208.50
HAY-SP-1040	Cyclac Bar Type (Concrete Pools)	51.50
HAY-SP-404	Eyebolt Assembly	64.95



PER-PH-52

THERMOMETERS

PS-082	Tie-off Thermometer	\$ 15.95
PS-084	Floating Thermometer	19.95
PS-088	Deluxe Chromed-Brass Thermometer	31.50
PM-52549	12" Round Terra Cotta Ceramic Thermometer	30.95
TEL-A00101	Inline Straight Thermometer	89.95

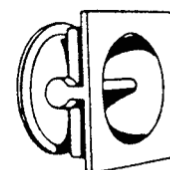

SP1040

QUARTZ WEATHER RESISTANT OUTDOOR CLOCKS

RS-16150	18" Round Patio Clock	\$ 48.95
----------	---------------------------------	----------

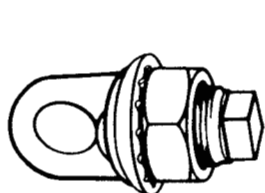

HAY-SP-404



PS-088



RS-16150



PS-084



SRS-A41141



SRS-A41156

Safety Equipment & Life Vests

LIFE HOOKS, RING BUOYS & RESCUE EQUIPMENT

RB-153	Anodized Aluminum Life Hook	\$ 47.50
JB-G20	20" USCG Approved Ring Buoy	108.95
JB-G24	24" USCG Approved Ring Buoy	121.95
JB-G30	30" USCG Approved Ring Buoy	148.95
PM-55552	17" Deluxe Plastic Ring Buoy	52.95
PM-55553	20" Deluxe Plastic Ring Buoy	60.95
REC-12256	Ring Buoy Holder	34.95
RS-37050	Rescue Tube I, 40"x6.5"x3.5" thick w/line	66.95
RS-37250	Rescue Tube II, 50"x 6.5"x3.5" thick	80.95
RS-2122550	Rescue Can, 25" with 7' tow strap	80.50
RS-10993	Rescue Spineboard 18" x 72"	193.00
RS-1381	Body Straps for Spineboard, (3)	33.95
RS-21430	Universal Head Immobilizer	95.50
RS-1050	Head Immobilizer Straps	22.75
REC-12016	CPR Microshield Rescue Breather	22.75
RS-59750	Bloodborne Pathogen Kit	29.95
ZEE-107	First Aid Kit, Nebraska Commercial Pools	329.95

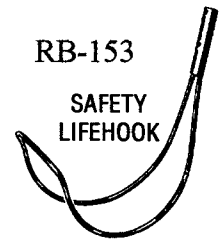

RB-153
SAFETY
LIFHOOK



LIFE
VESTS

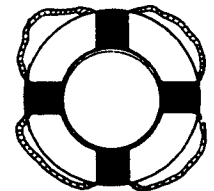

RING BUOY
JB-G24

DEPTH MARKERS & SAFETY TREADS

AQ-10019X	4" Black Plastic Depth Marker Numbers 0 thru 9 (Apply with Silicone or Epoxy)	\$ 4.50
INL-V6200	6" x 6" Stick On Depth Marker Numbers	16.95
REC-12394	2" x 24" Stick On Tread Material, black	2.50
REC-12401	6" x 24" Stick On Tread Material, black	6.95



RS-37250
RS-37050

USCG-APPROVED LIFE VESTS

Made from Ensolite, featuring Kwik-Snap buckles. Yellow.

TRC-1540500	Nylon Toddler Vest w/floating neck/head collar and leg strap, up to 40# child	\$ 34.95
TRC-1021012	Child Small w/leg strap, 30-50# 23"-25"	46.95
TRC-1021512	Child Medium, 50-90# 26"-29"	52.50
TRC-1022012	Adult X-small 31"-34"	66.95
TRC-1022512	Adult Small 34"-37"	72.50
TRC-1023012	Adult Medium 37"-40"	76.95
TRC-1023512	Adult Large 40"-43"	76.95
TRC-1024012	Adult X-Large 43"-46"	76.95

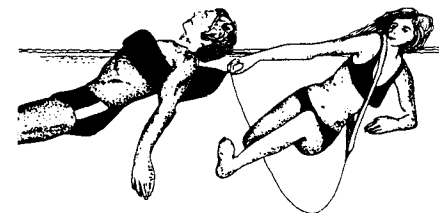

RS-37050

6345
789½

AQ-10019X

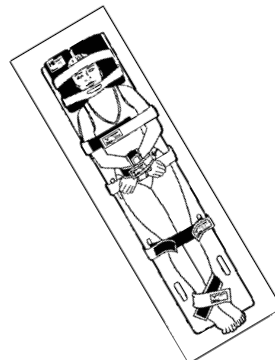

RS-10993
RS-1381

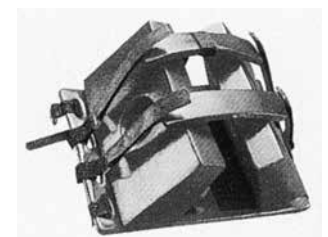

RS-21430

Paint

The success of any pool painting project is 90% dependent on **PROPER SURFACE PREPARATION**. We recommend washing with 910 Washing Compound, acid washing, then a mild 910 wash once again. We have a detailed instruction bulletin to assist you in your preparation plans.

RUBBER BASE POOL ENAMEL 30% Solids, 70% Volatile

Minimum wait to fill pool: 5 days (14 days is best)

KEL-290G	Paralon 2 White-Gallon	\$ 135.75
	(Also Available: Blue Ice-291G, Bikini Blue-292G, Black-297G)	
KEL-1108G	Rubber Base Solvent-Gallon	86.95



KEL-290G

EPOXY POOL COATINGS 80% Solids, 20% Volatile

Minimum wait to fill pool: 6-7 days, depending on temperature

KEL-222G	Poxolon White-Gallon	\$166.50
	(Also Available: Blue Ice-225G, Bikini Blue-228G, Black-226G)	
KEL-1109G	Epoxy Solvent-Gallon	86.95
KEL-216G	Gunzite Primer (Rough Concrete & F/G)-Gallon	124.50
KEL-214G	Poxoprime II Primer (Smooth Concrete)-Gallon	124.50
KEL-219G	Steel Primer-Gallon	131.95
KEL-390G	Zeron White-Gallon (one-coat epoxy paint)	168.95
	(Also Available: Blue Ice-391G, Bikini Blue-392G)	

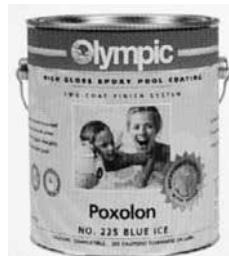

KEL-222G

NONSLIP KITS FOR DIVING BOARDS

KEL-U100	White Diving Board Refinishing Kit.	\$ 144.50
	(Also Available: Blue Ice-U101, or Bikini Blue-U102)	



KEL-216G

RUBBER BASE PATIO TONES FOR CONCRETE DECKS

Call for colors available - Gallon \$ 79.95

CAULK & MISCELLANEOUS

HS-31397	White Silicone Caulk, tube	\$ 29.95
KEL-950	Permaseal Caulk Joint Filler, tube	31.95
KEL-935VG	Thermolastic Epoxy Vertical Joint Filler-Gallon.	234.95
VUL-45W	Vulkem Caulk, Horizontal Joints, 32 oz. tube.	44.95
VUL-116W	Vulkem Caulk, Vertical Joints, small tube.	19.95
PEC-NR-201	Self-leveling Urethane Caulk, 32 oz. tube	39.95
KEL-934.5	1/2" Backer rod filler for caulking, per foot47
EPB-530318	Epoxy Putty Underwater Repair, 2-tube set	40.50
KEL-960QT	Concrete Pool Patch-Quart	41.50
KEL-245G	Prep Magic One Step Surface Cleaner	48.50
KEL-910G	Pool Washing Compound-Gallon	57.50
KEL-910QT	Pool Washing Compound-Quart	21.95
CER-ASA/128-1	AcidMagic Buffered Muriatic Acid-Gallon.	21.95



EPB-530318

**OTHER PATCHING/FILLER COMPOUNDS AVAILABLE
GIVE US A CALL!!!**

Replacement Liners, Patch Kits & Games

ABOVE-GROUND POOL REPLACEMENT LINERS Blue Overlap

FWP-R1236-10	12' Round x 36" deep, 10 mil	\$199.95
FWP-R1248-20	12' Round x 48" deep, 20 mil	275.50
FWP-R1548-20	15' Round x 48" deep, 20 mil	306.95
FWP-R1848-20	18' Round x 48" deep, 20 mil	336.50
FWP-R2148-20	21' Round x 48" deep, 20 mil	441.50
FWP-R2448-20	24' Round x 48" deep, 20 mil	462.95
FWP-R2748-20	27' Round x 48" deep, 20 mil	504.50
FWP-OV122448-20	12' x 24' Oval x 48" deep, 20 mil	445.75
FWP-OV153052-20	15' x 30' Oval x 52" deep, 20 mil	747.50
FWP-OV183352-20	18' x 33' Oval x 52" deep, 20 mil	874.95

Other sizes available. Call for quote!



LINER ACCESSORIES

SWL-ACCOP	24" x 1" Above-ground Pool Coping.	\$ 1.95
SWL-COVE	4' Piece Above-ground Pool Cove.	14.95
CAN-4320119	1/8" x 42" x 125' Wallfoam, 2# Density	124.50

VINYL PATCH KITS

BOX-110	Underwater Mend with Patch, 4 oz. (500 sq. in.)	\$ 36.95
BOX-859	Vinyl Pool Repair Kit, 2 oz. (130 sq. in.)	14.95
PM-30280	Underwater Patch Kit, 2 oz. (130 sq. in.)	18.95



GAMES & GOGGLES

Others Available - CALL US!

PM-72702	Dive 'N' Relay Sticks (new-lay flat)	\$ 16.95
PM-72703	Dive Rings, Package of 4	23.50
PM-72708	Super Combo VB/Badminton, 7.5' floating net	133.50
PM-72710	Dive Discs, Package of 6.	11.25
PM-72715	Dolphin Slalom Game, 4-30" hoops	27.50
PM-72720	Rotten Egg Game (6-pak)	15.50
PM-72785	Across-Pool Combo Volleyball/Badminton.	235.50
PM-94350	Compi 1 Swim Goggles for young swimmers	8.25
PM-50513	Deluxe Swim Board, Solid Foam, 11.5" x 18"	26.50
PM-50515	Polyform Swim Board with handles 12" x 27"	26.95

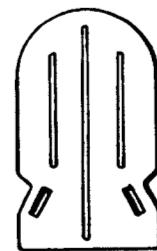

PM-50515

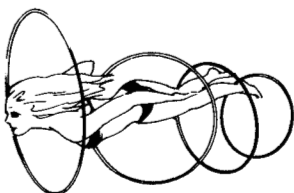

PM-72715



PM-72708

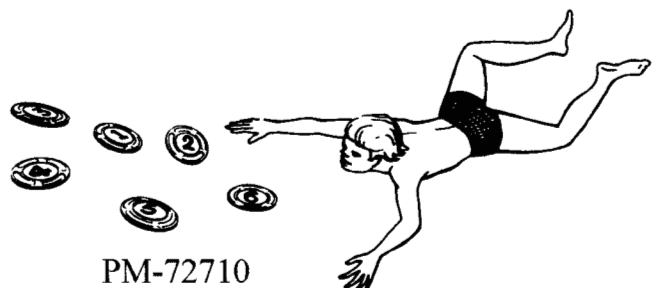

PM-72710

Heaters

COATES ELECTRIC POOL HEATERS 240V, single phase

COA-86512412	12 KW, 12412CE	51 Amp.	\$3844.00
COA-86512415	15 KW, 12415CE	64 Amp.	3905.00
COA-86512418	18 KW, 12418CE	77 Amp.	3925.00
COA-86512424	24 KW, 12424CPH	102 Amp.	4685.00
COA-86512430	30 KW, 12430CPH	128 Amp.	4743.00
COA-86512436	36 KW, 12436PHS	153 Amp.	5770.00
COA-86512445	45 KW, 12445PHS	191 Amp.	5874.00
COA-86512454	54 KW, 12454PHS-4	225 Amp.	6377.00

Other sizes available, up to 300 KW. Call for quotes.

*** Specify Voltage (208V, 240V or 480V)

*** Specify Phase (Single or Three)

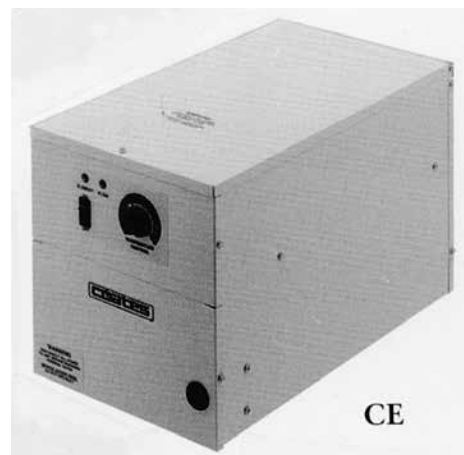

CE

COATES ELECTRIC SPA HEATERS

COA-86652406	5.5 KW, 240V, In-Line, 6ILS (w/pres. switch)	\$ 914.00
COA-86659915	1.5 KW, 120V, In-Line, 1.5ILS (w/pres. switch)	740.00
COA-12406ST	5.5 KW, 240V, w/ Internal flow switch	1110.00
COA-12411ST	11 KW, 240V, w/ Internal flow switch	1141.00

COATES ELECTRIC POOL HEATERS

MODEL	DESIRED TEMPERATURE RISE				
	10°	15°	20°	25°	30°
COATES	POOL SURFACE AREA IN SQUARE FEET				
12KW	341	227	171	136	114
15KW	427	284	213	170	142
18KW	512	341	256	227	170
24KW	683	455	341	273	227
30KW	853	569	427	341	284
36KW	1024	683	512	409	341
45KW	1280	853	640	512	426
54KW	1535	1023	767	614	511



CPH



6ILS

FAFCO SOLAR HEAT

Let us figure a system for you!

FAF-975	Above-ground Pool SunSaver™ System	
	Heats 18' - 24' Round Pool.	\$ 759.00
FAF-818	4' x 8' SunSaver™ Collector Panel	458.00
FAF-820	4' x 10' SunSaver™ Collector Panel	496.00
FAF-150	Panel Pack (1 required for each panel)	197.50
FAF-153	System Pack 2" (1 required for each system)	305.00
FAF-154	Bank Pack (required if multiple banks)	230.00
FAF-155	Split Pack (required if break in panel row)	175.00
FAF-162	Panel Repair Kit	122.50
FAF-2049	End Cap, Rubber	17.00
FAF-3401	Sensor Kit, 300D Series	210.00
FAF-600	Thermo Valve Control, non-electric	660.00



ST

For 240V use only.
Flow switch is built-in.

**PRICES CHANGE OFTEN
PLEASE CALL FOR QUOTE**

Heaters

Heaters and parts also available for **COMFORTZONE, COATES, PUREX, RAYPAK** and many other kinds. Just give us a call!!!

TELEDYNE LAARS POOL HEATERS

Specify: Natural Gas or Propane; Outdoor or Indoor

Millivolt: TEL-LG (has pilot) Electronic Thermostat: TEL-LD

	TEL-LG	TEL-LD
125,000 BTU Heater	\$3099.00	\$ 3199.00
175,000 BTU Heater	3599.00	3699.00
250,000 BTU Heater	4078.00	4178.00
325,000 BTU Heater	4499.00	4599.00
400,000 BTU Heater	4985.00	5085.00

***For Vent or Drafthood , add ... \$ 250.00

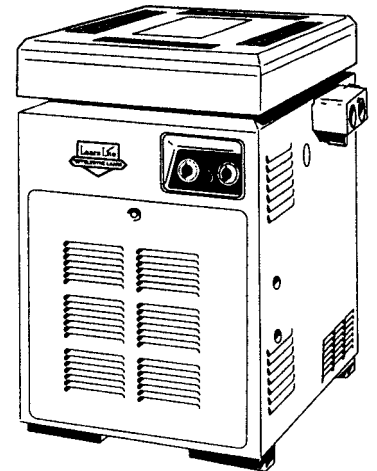

Fast Heating Table

DESIRED TEMPERATURE RISE	HEATER MODEL NUMBER:				
	125	175	250	325	400
	Maximum Square Footage of Pool				
15°	345	476	690	880	1070
20°	255	358	510	675	800
25°	205	287	410	555	642
30°	172	240	343	443	533
35°	147	205	293	380	460

Temperature Maintenance Table

DESIRED TEMPERATURE RISE	HEATER MODEL NUMBER:				
	125	175	250	325	400
	Maximum Square Footage of Pool				
15°	620	855	1239	1580	1920
20°	456	642	912	1210	1435
25°	368	515	737	995	1151
30°	308	430	616	794	955
35°	263	367	526	683	826

1. Heating tables are based on 3 1/2 mph average wind and average pool depth of 5.5 feet. 2. All models certified by American Gas Association as gas-fired Swimming Pool Heater for natural gas or propane gas for outdoor installation and for indoor installation. All models constructed for 125 psi working pressure. 3. Reduce input ratings by 4% for each 1000 feet above sea level. 4. Teledyne Laars maintains a policy of continuous improvement. We therefore reserve the right to change specifications without notice.

**COMMERCIAL HEATERS-FOB FACTORY

Specify: Indoor or Outdoor

INDOOR

OUTDOOR

Specify: Natural Gas or Propane

TEL-AP-500	500,000 BTU Heater	... \$18,307.00	... \$19,807.00
TEL-AP-600	600,000 BTU Heater	... 18,903.00	... 20,403.00
TEL-AP-715	715,000 BTU Heater	... 19,290.00	... 20,790.00
TEL-AP-850	850,000 BTU Heater	... 20,180.00	... 21,680.00
TEL-AP-1010	1,010,000 BTU Heater	... 20,318.00	... 21,818.00
TEL-AP-1200	1,200,000 BTU Heater	... 20,888.00	... 22,388.00
TEL-AP-1430	1,430,000 BTU Heater	... 21,417.00	... 22,917.00
TEL-AP-1670	1,670,000 BTU Heater	... 22,448.00	... 23,948.00
TEL-AP-1825	1,825,000 BTU Heater	... 22,954.00	... 24,454.00

For installation above 2000 feet altitude, derate input 4% per 1000 feet.

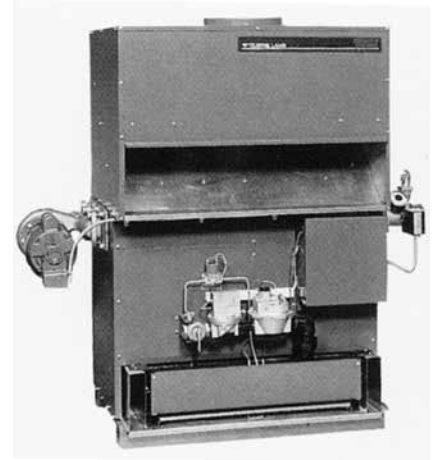

Commercial

HEAT SINKS Stainless Steel / Quick Disconnect

SRS-HS15-8	1-1/2" x 8" Drop Heat Sink, each	... \$ 99.95
SRS-HS15-17	1-1/2" x 17" Drop Heat Sink, each	... 105.50
SRS-HS15-21	1-1/2" x 21" Drop Heat Sink, each	... 119.95
SRS-HS20-20	2" x 20" Drop Heat Sink, each	... 169.50

Other sizes available.

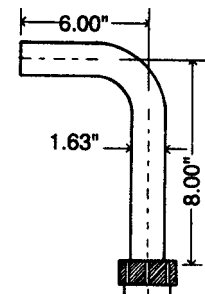

**PRICES CHANGE OFTEN
PLEASE CALL FOR QUOTE**

Pumps & Above-Ground Pool Paks

Pumps and parts are also available for AMERICAN, AQUAFLO, HAYWARD, JACUZZI, MARLOW, PACFAB, PREMIER, PUREX, SWIMQUIP, and many other kinds. Just give us a call!!!!

PUMPS, Uprated, Low Service Factor

STA-P6E6D-L	.75 HP Max-E-Pro, 115/230V, 1.5" In/Out	\$1640.00
STA-P6E6E-L	1 HP Max-E-Pro, 115/230V, 2" In/Out	1685.95
STA-P6E6F-L	1.5 HP Max-E-Pro, 115/230V, 2" In/Out.	1765.95
STA-P6E6G-L	2 HP Max-E-Pro, 115/230V, 2" In/Out	2012.00
PEN-011077	3 HP Intelliflo, 230V, Variable Speed	2565.95
PEN-011512	.75 HP Whisperflo, 115/230V, 1.5" In/Out	1524.00
PEN-011513	1 HP Whisperflo, 115/230V, 2" In/Out	1605.00
PEN-011514	1.5 HP Whisperflo, 115/230V, 2" In/Out.	1684.95

Non-corrosive All Bronze Self-Priming Pumps, High Service Factor:

STA-CF6EF-L	1.5 HP, 230V, 6" Trap, 2"/1.5" In/Out	\$1954.00
STA-CF6EG-L	2 HP, 230V, 6" Trap, 2"/1.5" In/Out	2074.00
STA-CF6H-123	3 HP, 230V, 6" Trap, 2"/1.5" In/Out	2640.00

Rugged Cast Iron Commercial Self-Priming Pumps:

(Bronze impeller, 4"x6" flange connection. Must add trap.)

STA-CSPHK3	7.5 HP, 3 Phase, 230/460V	\$5175.00
STA-CSPHL3	10HP, 3 Phase, 230/460V	5900.00
STA-CSPHM3	15HP, 3 Phase, 230/460V	6455.00
STA-CSPHN3	20HP, 3 Phase, 230/460V	8698.00

For "CCSP" series epoxy-coating on pumps, add 2555.00

STA-PKG-184	1100 Cu.In. Capacity Cast Iron Trap, 6" Flange	3884.00
STA-PKG-184C	1100 Cu.In. Epoxy-coated Trap, 6" Flange	5785.00

PACFAB ABOVE-GROUND EQUIPMENT PACKS

(110v, 25' Cord & Hose Kit)

PFB-14-1638	TA35D Filter, ¾ HP Pump, 16,800 gal/8 hr.	\$ 1025.95
PFB-14-1644	TA40D Filter, ¾ HP Pump, 19,200 gal/8 hr.	1140.95

HAYWARD PUMPS

HAY-SP-1575-LX	¾ HP Power Flo with 6' cord, 115V \$ 619.95
HAY-SP-2607X10	1 HP Super Pump, 115/230V 859.95

EXPLODED VIEW WHISPERFLO

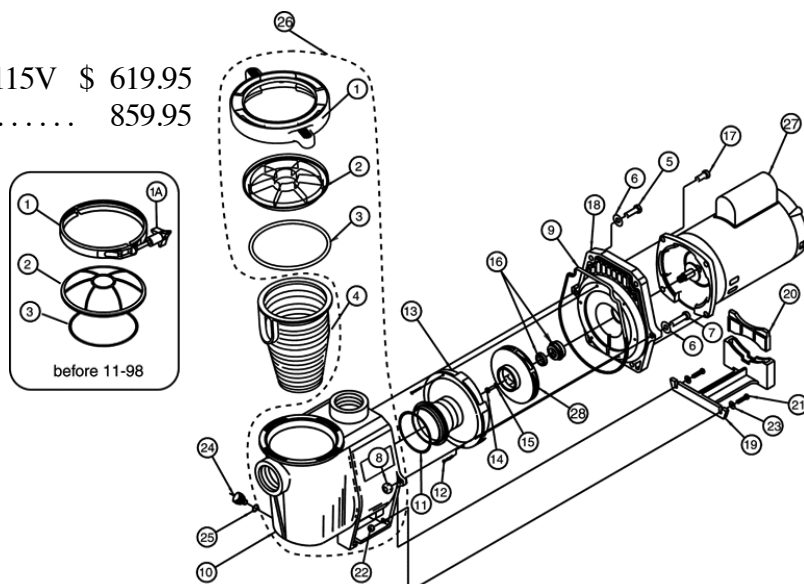

HAY-SP-2607X10



PFB-14-1644

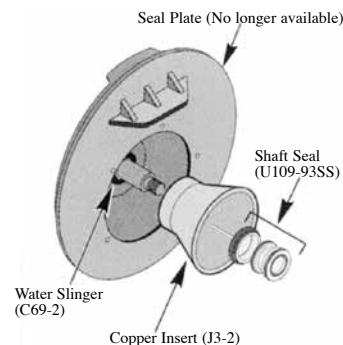

3A - Old Style (Pre-1998)

Purex Commercial C-Series Brass Pump

Item No.	Part No.	Mfg. No.	C SERIES PUMPS	
			Description	
3	07-5280		Hand nut assy. - brass, 2 req.	
4	07-5275		Cover, C16 - brass	
5	07-1433	P24150	O-ring C-18	
6	07-1551	P24950	Plug pipe ¼ in. brass, 2 req.	
7	07-5271		Pot mach strain brass	
8	07-2795	S01200	Basket, C-29 s/s 11 in.	
9	07-5273		Volute C-2 brass	
11	07-0943	P11050	Gasket Flg. P-1355 in.	
12	07-1683	P27400	Screw ¼-10 x 1.75 HH brs. P-12, 4 req.	
13	07-5287		Foot C-4 coated	
14	07-1688	P27600	Screw 5/8 11 x 1 stl. HH, 2 req.	
15	07-1037	P13550	Imp. - C-35 lock screw	
16	07-1048	P19025	Imp. wsh. C-71	
17	07-3828		Imp.-CH-50/CHK-50 5 hp 1 PH high hd.	
	07-0228		Imp.-CM-50/CMK-50 5 hp 1 PH med. hd.	
	07-3829		Imp.-CHK-75 7.5 hp 3 PH high hd.	
	07-0227		Imp.-CMK-75 7.5 hp 3 PH med. hd.	
	07-3830		Imp.-CHK-100 10 hp 3 PH high hd.	
	07-0226		Imp.-CMK-100 10 hp 3 PH med hd.	
	07-3831		Imp.-CHK-150 15 hp 3 PH high hd.	
	07-0225		Imp.-CMK-150 15 hp 3 PH med. hd.	
	07-3832		Imp.-CHK-200 20 hp 3 PH high hd.	
18	07-1725	P28175	Seal (C-7) PS-360	
19	07-0906	P09800	Flg., mach-C-52 brass	
20	07-1423	P24050	O-ring C-70	
21	07-1681	P27327	Screw 3/8 16 x ¼ in. CSHH, 2 req.	
22	07-2185	P35100	Water slinger C-115	
23	07-1046	P16550	Imp. key 3/16 in. sq. - Replaces P99999	
24	07-1687	P27575	Screw ½ -13x 1.25 stl HH, 4 req.	
25	07-1366	P22475	Mtr. 5 hp 1PH C, 100 lbs.	
	07-1364	P22425	Mtr. 5 hp 3PH C, 91 lbs.	
	07-1365	P22450	Mtr. 7.5 hp 3PH C, 86 lbs.	
	07-1363	P22400	Mtr. 10 hp 3PH C, 132 lbs.	
	07-1361	P22380	Mtr. 15 hp 3PH C, 144 lbs.	
	07-1362	P22381	Mtr. 20 hp 3PH C, 244 lbs.	
Motor subassemblies include items #15 thru 25				
	07-3260	S18263	Mtr. subassy. CM-50	
	07-3264	S18283	Mtr. subassy. CH-50	
	07-3262	S18277	Mtr. subassy. CMK-50	
	07-3265	S18285	Mtr. subassy. CHK-50	
	07-3263	S18279	Mtr. subassy. CMK-75	
	07-3266	S18286	Mtr. subassy. CHK-75	
	07-3680	S18281	Mtr. subassy. CMK-100	
	07-3267	S18287	Mtr. subassy. CHK-100	
	07-3261	S18275	Mtr. subassy. CMK-150	
	07-3268	S18294	Mtr. subassy. CHK-150	
	07-3269	S18295	Mtr. subassy. CHK-200	

FEATURES

- Large Commercial Pump with s/s basket
- Easy serviceability
- All-bronze construction for strength and durability
- 6 in. suction and 4 in. discharge for maximum capabilities
- Self-priming to insure proper filtration

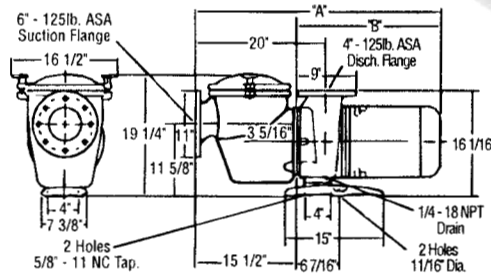

- Heavy-gauge stainless steel strainer basket with an open area 5 times the area of the suction port
- Closed impeller for longer motor bearing life
- Heat-resistant seal capable of operation at up to 150°F
- Available in single and three-phase, 50 and 60-Hertz models
- One-year Warranty

CHK/CMK Three Phase 50/60 Cycle

Item No.	Model	Head	Voltage	H.P.	Price
PUX-011657	CHK-50	High	220/440V	5	\$9350.00
PUX-011652	CMK-50	Medium	220/440V	5	9350.00
PUX-011658	CHK-75	High	220/440V	7.5	9475.00
PUX-011653	CMK-75	Medium	220/440V	7.5	9475.00
PUX-011659	CHK-100	High	220/440V	10	10350.00
PUX-011654	CMK-100	Medium	220/440V	10	10350.00
PUX-011660	CHK-150	High	220/440V	15	10875.00
PUX-011655	CMK-150	Medium	220/440V	15	10875.00
PUX-011661	CHK-200	High	220/440V	20	13150.00

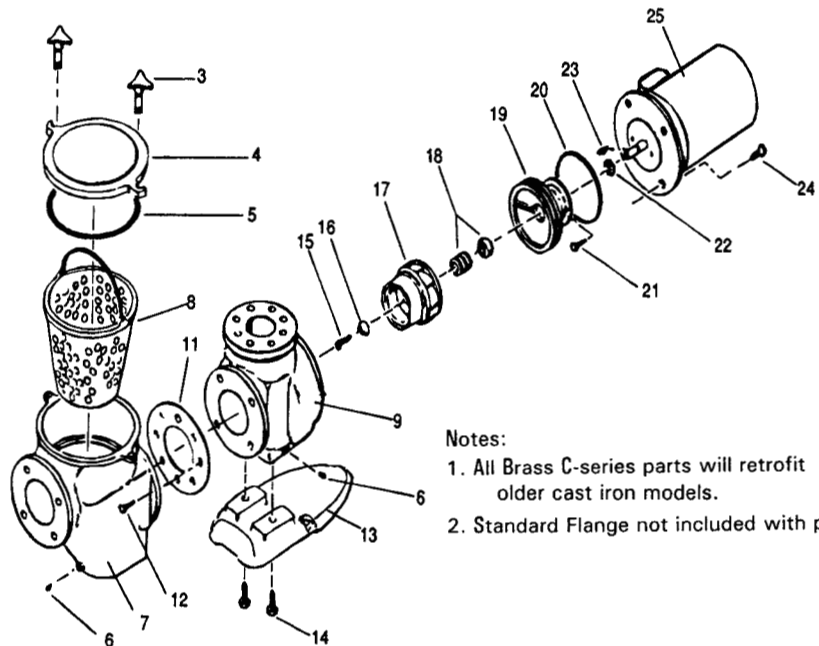

Notes:

1. All Brass C-series parts will retrofit older cast iron models.
2. Standard Flange not included with pump.

Sand & DE Filters & Valves

FIBERGLASS TRITON II SAND FILTER (Parts Breakdown - Next Page)

Full 10-year tank warranty. Must add valve.

PFB-14-0236	TR-40, 1.92 Sq. Ft. filter area, 19" tank	\$ 1109.95
PFB-14-0264	TR-60, 3.14 Sq.Ft. filter area, 24" tank	1458.50
PFB-14-0210	TR-100, 4.91 Sq. Ft. filter area, 30" tank	1917.50
PFB-14-0243	TR-140, 7.06 Sq.Ft. filter area, 36" tank	2605.50
PFB-14-0316	TR-140C Commercial Filter	2776.95
PFB-14-0342	TR-140C-3 Comm. Filter, 3" Flange Connections	3447.95



26-1173

FIBERGLASS TAGELUS DLX SAND FILTER (Full 10-yr tank warranty)

PFB-14-4126	TA-40D w/ 1.5" top-clamp valve, 19" tank	\$ 1028.75
PFB-14-5241	TA-60D w/ 1.5" top-clamp valve, 24" tank	1195.95
PFB-14-5240	TA-100D w/ 2" top clamp valve, 30" tank	1576.50

MULTIPOINT AND SLIDE VALVES

PFB-26-1173	1.5" Multiport Valve, TR	\$ 315.50
PFB-26-1050	2" Hi-Flow Multiport Valve, TR	399.25
PFB-26-1055	2" Multiport Valve (26-1071), TR	486.95
PFB-26-2506	1.5" M/P Valve, Top Clamp, TA-35,40,50,60D	337.50
PFB-26-1185	2" M/P Valve, Top Clamp, TA-100D	499.95
PFB-26-1177	1.5" Multiport Valve, (D.E.), NS	315.50
PFB-26-1152	2" Multiport Valve, (D.E.), NS	404.95
PFB-26-3064	2" PVC Slide Valve, TR, NS (must specify)	228.50
(2" PVC Slide Valve Parts Breakdown on Next Page)		
PFB-26-1124	1.5" M/P Valve, TA<12/1/91, V-thread, Top Mount	344.95
PFB-26-1130	1.5" M/P Valve, TA>12/1/91, Buttress-Thread	344.95



26-3064

PARTS

(From Breakdowns on Next Page)

PFB-15-2290	TR-40, 50, 60 Lateral (#15 on breakdown)	\$ 18.95
PFB-15-4495	Triton Closure Dome O-ring (#7 on breakdown)	10.95
PFB-15-4559	Triton Closure Dome, V-Thread (#6 on breakdown)	174.95
PFB-15-4570	Triton Closure Dome, Buttress -Thread (#6 on breakdown)	194.95
PFB-27-3064	2" PVC Slide Valve Position Bracket (#7 on breakdown)	59.95
PFB-27-3089	2" PVC Slide Valve Plastic Shaft Handle (#10/breakdown)	37.50
PFB-27-3106	2" PVC Slide Valve Piston Shaft (#2 on breakdown)	192.50
PFB-27-3090	2" PVC Slide Valve O-ring (#1 on breakdown)	5.95



TRITON II



TRITON C-3



TAGELUS

Sand & DE Filters & Valves

TRITON SAND FILTER PARTS BREAKDOWN

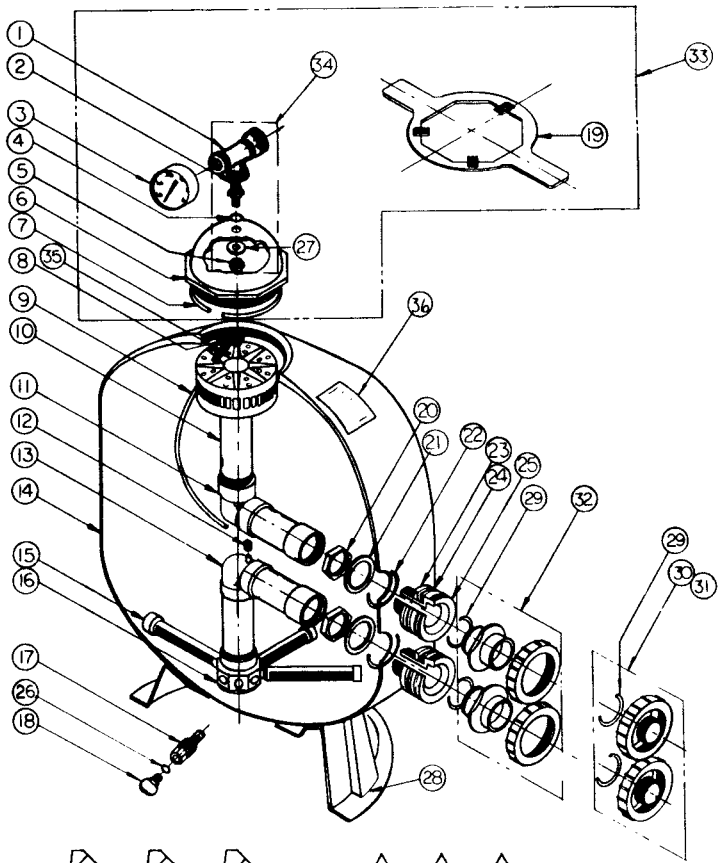

6" BUTTRESS THREAD

DETAIL A
AFTER DEC. 1, 1991



6" 'V' THREAD

DETAIL B
BEFORE DEC. 1, 1991

2" PVC SLIDE VALVE PISTON ROD ASSEMBLY (Fits PFB-1165 Slide Valve)

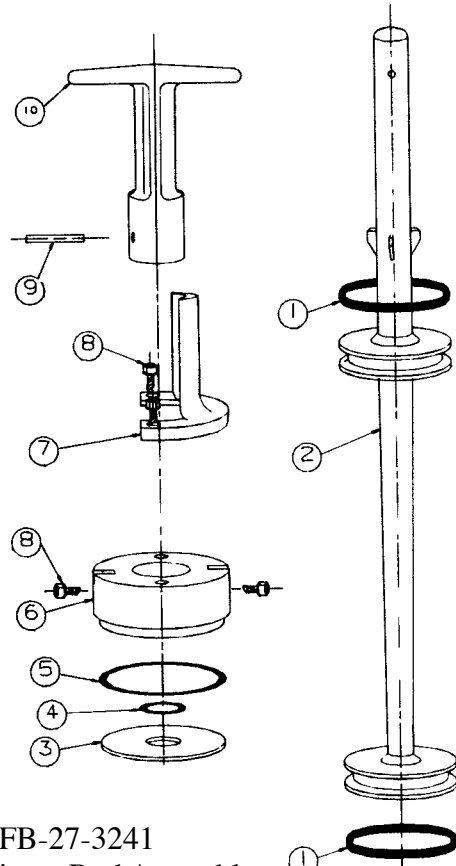

PFB-27-3241
Piston Rod Assembly
Complete \$124.50

Many Brands and Sizes of DE Filter Elements and Replacement
Covers are Available – Call us with your specs!!!

WATERITE DE FILTER ELEMENTS

WAT-PS2.5COM	4"x4"x24" DE Element, complete	\$155.50
WAT-PS2.5CORE	4"x4"x24" DE Element, core	124.95
WAT-PS2.5COV	4"x4"x24" DE Element, cover	63.95
WAT-PS3COM	4"x4"x28" DE Element, complete	313.75
WAT-PS3CORE	4"x4"x28" DE Element, core	213.95
WAT-PS3COV	4"x4"x28" DE Element, cover	99.95
WAT-PS4COM	4"x4"x35" DE Element, complete	355.75
WAT-PS4CORE	4"x4"x35" DE Element, core	261.95
WAT-PS4COV	4"x4"x35" DE Element, cover	109.95
WAT-ORING	Replacement O-ring	28.95

We will gladly bid quantity orders!

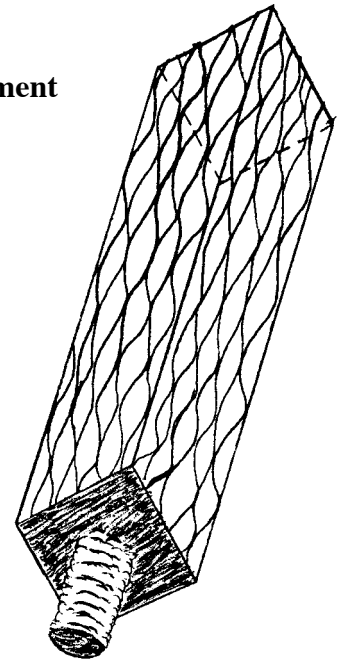

Commercial Sand Filters

REPLACEMENT FOR SWIMQUIP HI-RATE-HRL SINGLE TANK FILTERS

Systems complete with internal distribution & collection systems, gauge panel with two 0-60 psi gauges, manual & automatic air relief valves, 1-1/2" backwash sight glass, side mounted cast iron face pipe assembly with butterfly valves, strap or jack legs. Filter media not included.

** Specify if linkage for single lever operation is necessary.

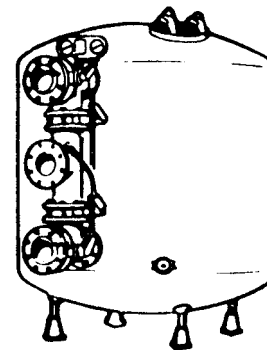

HRL

CALL FOR QUOTE

Tank Diameter	Sq.Ft. Filter Area	Face Pipe Size	Total GPM	Approx. Weight
48"	12.6	4"	252	1095
54"	15.9	4"	318	1215
60"	19.6	4"	392	1529
66"	23.7	4"	355	1919
66"	23.7	6"	474	1978
72"	28.3	6"	566	2218
78"	33.2	6"	664	2530
84"	38.5	6"	770	3280
90"	44.2	6"	884	3887
96"	50.3	6"	755	4337
96"	50.3	8"	1006	4429
102"	56.7	6"	851	5110
102"	56.7	8"	1134	5405

KEY-4VALVE	4" HRL Replacement Butterfly Valve	\$449.95
KEY-6VALVE	6" HRL Replacement Butterfly Valve	689.95
SPE-851-040	4" Flange, Schedule 80, Slip	65.50
SPE-851-060	6" Flange, Schedule 80, Slip	74.95

CARTRIDGE FILTERS

Filters and parts are available for **AMERICAN, HARMSCO, HAYWARD, JACUZZI, PREMIER, PUREX, RAINBOW, STARITE, SWIMQUIP**, and many other kinds. Just call!!!

		(Complete Units)
HAY-C-500	50 Sq. Ft. Star-Clear Filter, 1½" In/Out \$750.00
HAY-C-751-2	75 Sq. Ft. Star-Clear+ Filter, 2" In/Out 850.50
HAY-C-1200-2	120 Sq. Ft. Star-Clear+ Filter, 2" In/Out 959.50
STA-PTM-50	50 Sq. Ft. Posi-Flo II Filter, 1½" In/Out 694.75
STA-PTM-70	70 Sq. Ft. Posi-Flo II Filter, 1½" In/Out 768.00
STA-PTM-100	100 Sq. Ft. Posi-Flo II Filter, 1½" In/Out 968.00
STA-PTM-135	135 Sq. Ft. Posi-Flo II Filter, 1½" In/Out 1094.95



C-500 Star-Clear Filter

REPLACEMENT CARTRIDGE FILTERS ON PAGE 38

Vacuum Carts, Pool Cleaners, Flow Meters,

Gauges & Sight Glasses

PORTABLE VACUUM CARTS

GLF-80-247-APC	1 HP pump, 105 sq ft cartridge filter, 80' electric cord	\$2795.00
GLF-80-247-122	3/4 HP electric motor, bronze pump, 80' cord . . .	2475.50
GLF-80-247-124	3 HP gasoline engine, cast iron pump	4250.95
GLF-80-GAS-APC	3 HP gasoline engine, 155 sq ft cartridge filter . .	5597.95

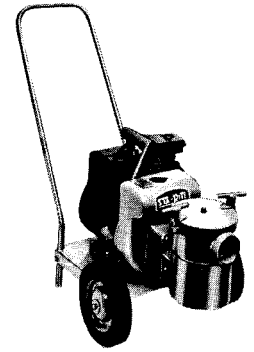

GLF-80-247-124

POOL CLEANERS

PB-MAX	Pool Blaster Max Cleaner - no cords.	\$ 379.50
PEN-920	Prowler 920	1895.95
DOL-10028	Dolphin Wave	4899.95



AQB-E1597

ROLA-CHEM FLOW METERS (Blue-White also available)

ROL-570341T	1.5" PVC, 20 GPM to 100 GPM	\$ 97.50
ROL-570351T	2" PVC, 40 GPM to 140 GPM	102.75
ROL-570361T	2.5" PVC, 80 GPM to 260 GPM	105.50
ROL-570371T	3" PVC, 100 GPM to 320 GPM	150.50
ROL-570381T	4" PVC, 150 GPM to 550 GPM	168.95
ROL-570391T	6" PVC, 300 GPM to 950 GPM	213.50
ROL-570401T	8" PVC, 600 GPM to 1800 GPM	229.50

Vertical pipe mount styles also available. CALL US!

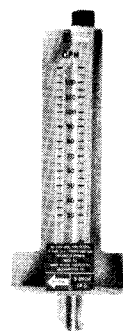

Top Mount
Flow Meter

GAUGES

AMG-PG602-4B	2" Pressure Gauge, 0-60 psi, back mount . .	\$ 16.95
AMG-PG602-4L	2" Pressure Gauge, 0-60 psi, side mount . . .	16.95
AMG-VG302-4L	2" Vacuum Gauge, 0-30 mmHg, side mount	29.50
AMG-PG10045	4.5" Pressure Gauge, 0-100 psi	69.95

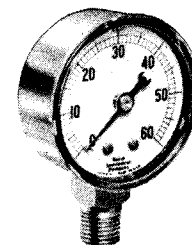

AMG-PG602-4L

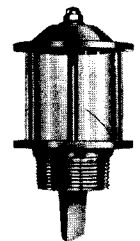

SRS-A41198-0

SIGHT GLASSES

HAY-SP-1072S	ABS In-Line Horizontal Flow-thru, 1.5" . . .	\$ 47.50
HAY-SP-1072T	As above, except threaded	47.50
HAY-SP-1074	ABS In-Line Horizontal Flow-thru, 2"	51.95
SRS-A41198-0	Cast Brass Vertical, 1.5" IP	247.50

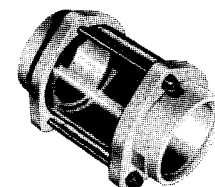

HAY-SP-1072

Pump & Skimmer Baskets

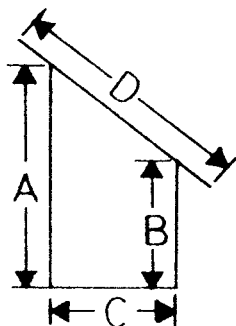

SLANT TOP

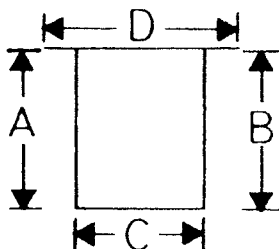

FLAT TOP

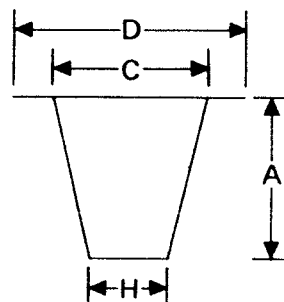

TAPERED BASKET

ORDERING BASKETS:

A = Height of Tall Side, Under the Lip.

B = Height of Short Side, Under the Lip.

C = Outside Diameter of Basket.

D = Width of Basket Including Lip.

H = Bottom Outside Diameter of Basket.

Designate if basket is for a skimmer or for a pump strainer pot.

The manufacturer's name can also be helpful.

(Below is a partial listing only--Call Us!)

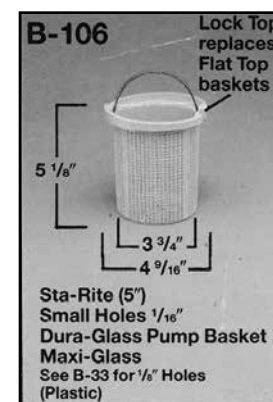
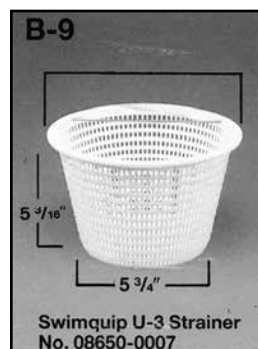
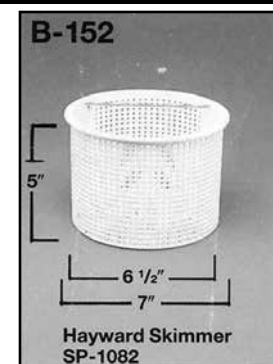

Measurement:

SLANT TOPS

	<u>A</u>	<u>B</u>	<u>C</u>	<u>D</u>	<u>H</u>	
B-11 Swimquip P-61	7-1/4"	4-3/4"	3-1/2"	5-13/16"	(w/bail)	\$ 39.95
B-17 Paddock	12-5/16"	7-13/16"	3-1/2"	6-5/16"		88.50
B-179 Swimquip 134023	9-9/16"	5-1/8"	4-1/16"	6-7/16"		169.95

FLAT TOPS

B-33 Starite, Premier	5-1/8"	5-1/8"	3-3/4"	4-9/16"	(w/bail)	\$ 23.50
B-34 Starite, Premier	4-13/16"	4-13/16"	4-7/8"	5-7/8"	(w/bail)	26.75
B-35 Starite, Premier	4-7/8"	4-7/8"	3-1/16"	3-13/16"	(w/bail)	23.50
B-37 American 850001	7-3/4"	7-3/4"	7-1/2"	8-7/16"		30.95
B-117 Hayward SP-1080E	5"	5"	6-1/2"	7"	(w/whole)	28.95
B-152 Hayward SP-1082CA	5"	5"	6-1/2"	7"		23.50
B-169 Hayward SP-1250R	5"	5"	3-7/16"	3-13/16"	(w/bail)	23.50
B-176 Marlow 2577400	5-5/8"	5-5/8"	5-1/4"	5-9/16"		31.95
B-188 Swimquip 162007	6-3/8"	6-3/8"	3-9/16"	4-1/4"	(w/bail)	23.50
B-345 Hayward	15-5/8"	15-5/8"	8-1/2"	9-1/4"		199.95

TAPERED

B-9 Swimquip U-3	5-3/16"	----	7-1/2"	8-5/16"	5-3/4"	\$ 23.50
B-136 Baker Hydro 51B1026	6"	----	6-3/4"	7-13/16"	5"	26.75
B-150 Purex C series	8-7/8"	----		10-13/16"	7-1/4"	179.50
B-203 Hayward SP-1094	3-1/8"	----		5-5/16"	3-5/8"	23.50

Skimmers, Drain Covers & Lights

SKIMMERS & ACCESSORIES

STA-08650-1403	U-3 Skimmer for Concrete Pools, 2" FIP\$ 188.95
STA-09655-1403	U-3 Skimmer for Vinyl/FG Pools, 2" FIP 235.95
STA-08650-0169	U-3 White Frame and Cover Lid 37.50
STA-08650-0058	U-3 White Cover Lid only 36.95
STA-WC37-503P	U-3 Extension Collar 43.95
STA-08650-0079	U-3 Float Valve w/ Diverter & O-ring 39.95
STA-08650-0022	U-3 Weir Assembly 34.50
HAY-SP-1085-2	Wide-Mouth Skimmer, Vinyl & FG 241.50
HAY-SP-1082-E	White Cover Lid, square, 1082 to 1086 32.50
HAY-SP-1082-K	Skimmer Weir, 1082-1086 & 1075-1077 24.75
HAY-SP-1105-2	Skim Vac, A-G Pool, 90 deg., 1.25" vac hose	.. 29.95
HAY-SP-1107	Skim Vac, I-G Pool, 1.5" Vac Hose Ftg. 29.95

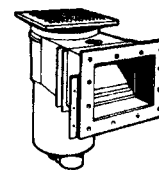

SP1084



STA-08650-0079



NWS-DS360

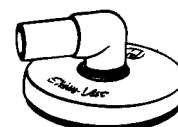

HAY-SP-1105-2

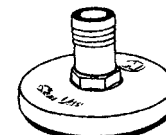

HAY-SP-1107

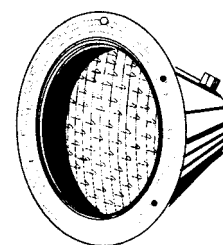

AMP-78458100

DRAIN COVERS

NWS-DS360	Anti-Entrapment Drain Cover, Round \$ 123.95
AS-R9MF101	Anti-Entrapment Drain Cover, 9 X 9 139.95
WWY-640-4740-VGB	Anti-Entrapment Drain Cover, 12 X 12 175.95
RS-NNA-2020-75	Anti-Entrapment Drain Cover, 20 X 20 1344.95
RS-NNA-2626-75	Anti-Entrapment Drain Cover, 26 X 26 1554.95

****ASTM/ANSI Certified Drain Covers for the Virginia Graeme-Baker Act****

POOL & SPA LIGHTS

STA-05086-0050	Swimquip 500W, 120V, 50' Cord, SS face ring	\$ 466.75
HAY-SP-583SL-50	Hayward 500W, 115V, 50' Cord, SS face ring	437.95
AMP-78458100	Amerlite 500W, 120V, 50' Cord, SS	431.50
AMP-77111100	Aqualite 100W, 120V, 15' Cord, SS, Spa	307.00
(American /Pacfab/Purex lights and niches interchange.)		
LB-POT-132	Light Wedge (holds light in niche w/out set screw)	31.95

LIGHT BULBS, LIGHT LENS & GASKETS

LB-500W120VR	500 Watt, 120Volt, Regular Base \$ 115.50
LB-400W120VR	400 Watt, 120Volt, Regular Base 74.50
LB-300W120VR	300 Watt, 120Volt, Regular Base 88.95
LB-300W12VR	300 Watt, 12 Volt, Regular Base 86.50
LB-4319	300 Watt, 12 Volt, Sealed Beam 84.95
LB-100W120VR	100 Watt, 120Volt, Regular Base 49.95
HS-30263	85 Watt, 120 Volt, Blue, Hot Spring Bulb 65.95
STA-05055-0003	Swimquip Clear Lens 109.95
STA-05057-0118	Swimquip Lens Gasket 76.95
HAY-SP-540-Z-1	Hayward Clear Lens 72.50
HAY-SP-540-Z-2	Hayward Lens Gasket 52.50
HAY-SP-501-HJ	Hayward Sealed Beam Light O-rings (2) 77.50
PFB-61-4515	Pacfab Clear Lens 64.95
PFB-61-4516	Pacfab Lens Gasket 59.50
AMP-791001	American Products Clear Lens 59.95
AMP-791016	American Products Lens Gasket 57.50

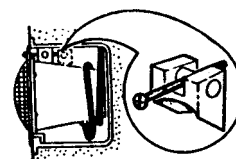

LB-POT-132

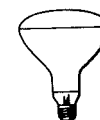

LB-500W120VR



LB-4319



LB-400W120VR

Solar Covers & Reels

We now have the computer program developed by the U.S. Department of Energy whereby we can evaluate your pool system and calculate the energy savings you would realize by installing a solar cover. We can also calculate the payback period on your cover investment. CALL US FOR DETAILS!!!

IN-GROUND SOLAR BLANKETS, 12 MIL

8' Panels, heat-sealed seams 5-year warranty (2-full, 3 pro-rated)		
CAN-12ML-1632	16' x 32' Rectangle	\$287.95
CAN-12ML-1634	16' x 34' Rectangle	319.95
CAN-12ML-1836	18' x 36' Rectangle	364.50
CAN-12ML-2040	20' x 40' Rectangle	449.95
OTHER REGULAR SIZES	Per Square Foot56
CUSTOM SIZES FOB FACTORY	Per Square Foot59

RESIDENTIAL DECK REELS for SOLAR BLANKETS

ODY-EMX	12'-20' Pool Width, Economy System	\$429.95
ODY-M600S2	14'-20' Pool Width, Deluxe System	657.50

COMMERCIAL 15 MIL 7- year warranty (2 full, 5 pro-rated)

CAN-15ML-2040	20' x 40' Rectangle	\$479.95
CAN-15ML-2444	24' x 44' Rectangle	597.95
CAN-15ML-2650	26' x 50' Rectangle	752.95
CUSTOM SIZES FOB FACTORY	Per Square Foot60

ABOVE-GROUND SOLAR BLANKET, 8 MIL

8' Panels, heat-sealed seams 3-year warranty (1-full, 2 pro-rated)		
CAN-8ML-R12	12' Round	\$ 58.95
CAN-8ML-R18	18' Round	132.75
CAN-8ML-R21	21' Round	181.50
CAN-8ML-R24	24' Round	235.95
CAN-8ML-R28	28' Round	320.95
CAN-8ML-OV1632	16' x 32' Oval	209.75
CAN-8ML-OV1834	18' x 34' Oval	250.75
OTHER SIZES AVAILABLE	Per Square Foot41

ABOVE-GROUND REEL SYSTEMS Fit round or oval pools.

ODY-M818	12'-18' Pool Width	\$423.50
ODY-M824	20'-24' Pool Width	489.95

BUBBLE SPA COVERS 6-Month Limited Warranty

CAN-SPA-66	6' x 6' Square	\$ 46.00
CAN-SPA-77	7' x 7' Square	54.00
CAN-SPA-88	8' x 8' Square	64.00
CAN-SPA-1010	10' x 10' Square	92.00

SOLAR BLANKET

Saves 70% or more on heating bills!

Enjoy a longer swimming season!

Cuts water evaporation!

**A size for every pool!
Easy to put on and remove**

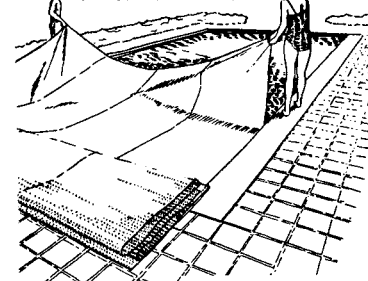

Unique air bubbles transmit and trap solar energy!

FREEDOM SERIES

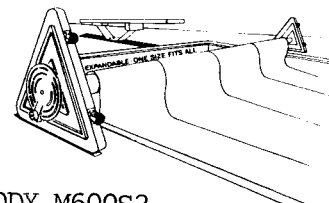

ODY-M600S2

EMX Reel System

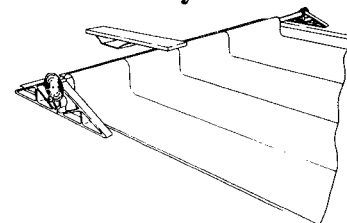

ABOVE GROUND REEL SYSTEMS

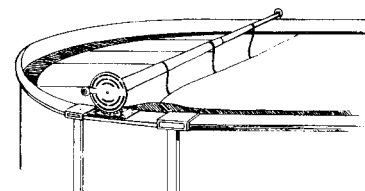

ODY-M824

Commercial Reels & Spa Covers

COMMERCIAL REELS, FOB Factory

SINGLE-TUBE REELS

GLI-4399012	Pools up to 12', Single-tube Reel, 3" Tube . . .	\$ 484.95
GLI-4399016	Pools up to 16', Single-tube Reel, 3" Tube . . .	519.95
GLI-4399020	Pools up to 20', Single-tube Reel, 3" Tube . . .	564.95
GLI-4399420	Pools up to 20', Single-tube Reel, 4" Tube . . .	653.95
GLI-4399024	Pools up to 24', Single-tube Reel, 4" Tube . . .	689.95

(4" tubes recommended for larger pools and/or heavy gauge solar blankets.)

DUAL-TUBE REELS

HOR-70-5005	Commercial Reel, Pool width max of 20'	\$2469.00
HOR-70-5001	Commercial Reel, Pool width max of 30'	3087.00
HOR-70-5011	Commercial Reel, Pool width max of 48'	3995.00

PARTS

CAN-1100	Tube End Steering Wheel	\$ 117.75
CAN-1007	Residential Black Yoke	45.50
CAN-2007	Commercial Black Yoke	58.25
CAN-2300	Sidewall Fastener Kit, Set of 4	49.95
CAN-2302	Overlap Splice Kit, Set of 4	23.50
CAN-2303	Flatfold Attachment, Set of 4	33.95
CAN-2304	Tandem Connector, Set of 4	58.50
CAN-2305	Blanket Bumpers, Set of 4	39.25
GLI-9300111	Blanket Clamps, each	10.95
CAN-2311	Cover Sheet, 36" x 20'	20.95
FEH-FG-RS26	White Strapping, 10 pieces x 26"	20.50

THERMAL FLOATING SPA COVERS

		Brown/Blue, 1/4" thick
SEN-THERM-66	6' x 6' Square	\$ 159.95
SEN-THERM-77	7' x 7' Square	221.50
SEN-THERM-88	8' x 8' Square	280.95
SEN-THERM-1010	10' x 10' Square	425.50
SEN-THERM-1212	12' x 12' Square	628.95

DELUXE VINYL SPA TOPS

Marine-grade vinyl cover, tapered 3-1/2" to 2-1/2" thick. Steel channel center reinforcement, vapor lock seal, 4 Sure-Loc Keyed Fasteners.
CALL FOR COLORS AND QUOTES. (We'll need exact dimensions of the spa.)

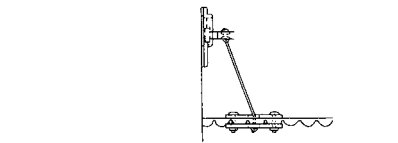

2300 Sidewall fastener kit (4)



2302 Overlap splice kit (4)

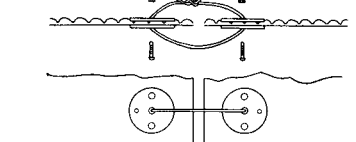

2303 Flat fold kit (4)

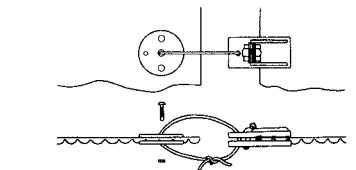

2304 Tandem connector kit (4)

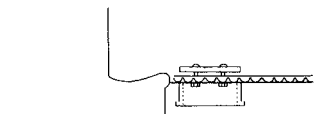

2305 Blanket bumpers (4)

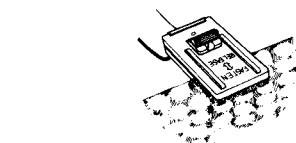

2308 Blanket clamps (4)



Winter Mesh & Automatic Safety Covers

MESH IN-GROUND POOL WINTER COVERS 12-year warranty

Allows water and melting snow to fall through, catching leaves and debris for easy clean-up. Anchors securely to deck. Keeps children and pets safe.

CATALOG NUMBER	POOL SIZE	COVER SIZE	PRICE
CAN-SAP-1428	14 x 28	16 x 30	\$1450.00
CAN-SAP-1632	16 x 32	18 x 34	1570.00
CAN-SAP-1634	16 x 34	18 x 36	1642.00
CAN-SAP-1836	18 x 36	20 x 38	1825.00
CAN-SAP-2040	20 x 40	22 x 42	1895.00
CAN-SAP-1836/Step	18 x 36	w/ step	1895.00

**WINTER COVERS
PROTECT
YOUR
INVESTMENT
-AND
MAKE
SPRING
CLEAN-UP
FASTER!!!**

Includes all necessary hardware, installation rod, anchor key and storage bag. For other sizes, step sections, extensions, ladder/handrail cutouts, etc., call for quotes.

AQUAMATIC COVER SYSTEM

On the surface, most pool covers look similar, but the most important and costly part of any pool cover is the mechanism. The patented mechanism of the **HYDRAMATIC** represents the best value for your durable investment. Designed to last the lifetime of your pool, the **HYDRAMATIC** is maintenance free, and the most reliable cover system manufactured with the most extensive warranty in the industry today.

CALL FOR A QUOTE TODAY!!!



An Aquamatic pool cover can be fabricated to fit almost any shaped pool, as long as there is room for the tracks to run parallel to each other, and the pool can fit within a 25' x 75' rectangle.



**A COVERED POOL
IS
A SAFER POOL.**



Winter Covers, Pumps & Water Tubes

ABOVE-GROUND POOL WINTER COVERS

Complete with grommets, rope and winch.

POOL SIZE	(7-yr warranty)	(10-yr warranty)
12' Round	CAN-AGCL-R12 ... \$ 59.00	CAN-AGES-R12 ... \$ 76.00
15' Round	CAN-AGCL-R15 ... 76.00	CAN-AGES-R15 ... 111.00
18' Round	CAN-AGCL-R18 ... 100.00	CAN-AGES-R18 ... 134.00
21' Round	CAN-AGCL-R21 ... 128.00	CAN-AGES-R21 ... 164.00
24' Round	CAN-AGCL-R24 ... 159.00	CAN-AGES-R24 ... 193.00
27/28' Round	CAN-AGCL-R28 ... 193.00	CAN-AGES-R28 ... 228.00
15'x30' Oval	CAN-AGCL-OV1530 146.00	CAN-AGES-OV1530 181.00
16'x32' Oval	CAN-AGCL-OV1632 158.00	CAN-AGES-OV1632 208.00
18'x34' Oval	CAN-AGCL-OV1834 188.00	CAN-AGES-OV1834 222.00

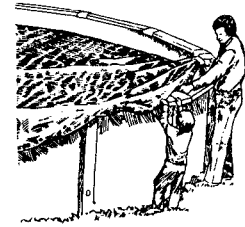

Saves money, chemicals and water!
Tough fabric...won't tear!
Cuts ultraviolet degradation!
Easy to install!
Fits any pool!

IN-GROUND POOL WINTER COVERS (Cover only)

Covers are 5' wider and 5' longer than pool dimensions.

Must order water tubes separately.

POOL SIZE	(7-yr warranty)	(10-yr warranty)
16' x 32'	CAN-IGCL-1632 ... \$158.00	CAN-IGES-1632 ... \$208.00
16' x 36'	CAN-IGCL-1636 ... 176.00	CAN-IGES-1636 ... 227.00
18' x 36'	CAN-IGCL-1836 ... 188.00	CAN-IGES-1836 ... 245.00
18' x 40'	CAN-IGCL-1840 ... 216.00	CAN-IGES-1840 ... 274.00
20' x 40'	CAN-IGCL-2040 ... 241.00	CAN-IGES-2040 ... 298.00
24' x 44'	CAN-IGCL-2444 ... 274.00	CAN-IGES-2444 ... 362.00
Step Section, Add.	111.00	123.00

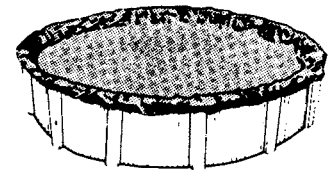

WATER TUBES For Holding Down In-Ground Winter Covers.

CAN-WT-1248S	12" x 4' Single Tube, Blue	\$ 10.95
CAN-WT-1296S	12" x 8' Single Tube, Blue	14.95
CAN-WT-1296D	12" x 8' Double Tube, Blue	13.95
CAN-WT-12120S	12" x 10' Single Tube, Blue	15.95
CAN-WT-12120D	12" x 10' Double Tube, Blue	16.95

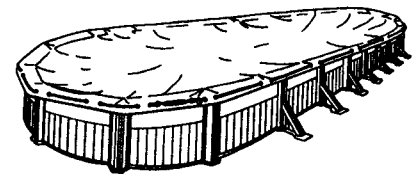

COVER PUMPS

110V, 25' Cord, GPH at 5' Height

LG-505025	5-MSP-25 Water Wizard, 1/6 HP, 1100 GPH	\$227.95
LG-508158	8-CIA-25, 2/5 HP, 3250 GPH	479.95

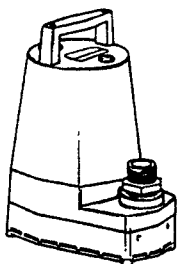

#505025

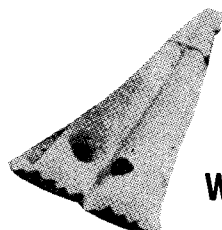

**DUAL
CHAMBER
WATER BAGS**

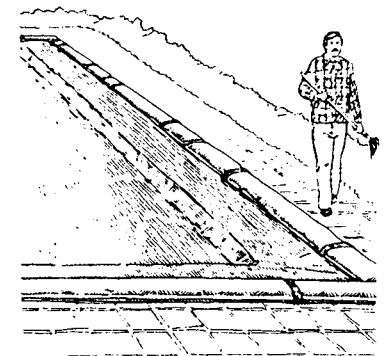

Ladders

LADDERS - STAINLESS STEEL TREADS

SRS-RLF-24S-2A	2 Tread S/S 1.90 x .049, 49" total length	\$ 701.75
SRS-RLF-24S-3B	3 Tread S/S 1.90 x .049, 59" total length	785.50
SRS-RLF-24S-4C	4 Tread S/S 1.90 x .049, 69" total length	860.50
SRS-LFB-30-3B	3 Tread S/S 1.90 x .065 w/ Crossbrace, 66"		1330.95
SRS-LFB-30-4C	4 Tread S/S 1.90 x .065 w/ Crossbrace, 78"		1457.50
SRS-LFB-30-5D	5 Tread S/S 1.90 x .065 w/ Crossbrace, 90"		1739.50

LFB-24 and LFB-36 series is available — CALL FOR QUOTES.

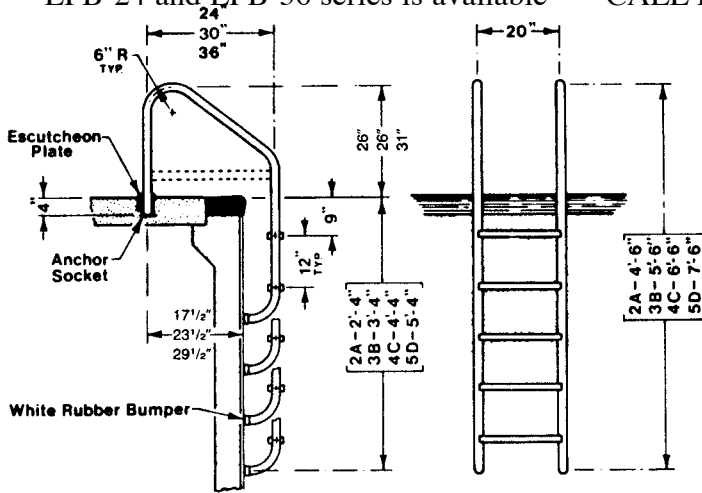
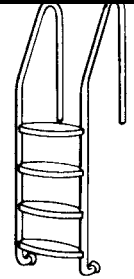

ADD 5" TO TOTAL LENGTH FOR LF AND LFB-36

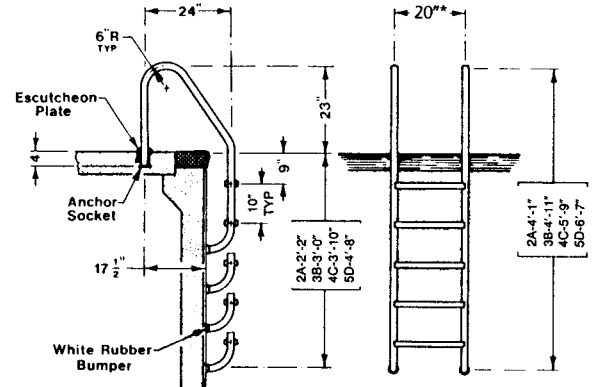

SRS-RLF-24S-xx Residential Ladder

SRS-LFB-30-xx Series Commercial Crossbrace Ladder

LADDERS - ABOVE GROUND POOLS

CON-626-B	In Pool Ladder, 14" wide	\$ 174.00
CON-726-B	A-Frame Safety Ladder with detachable steps	..	309.95
DOT-SPL-4	Aluminum A-Frame In/Out Safety Ladder	355.00
DOT-SPL-4000	Aluminum In Pool Ladder with Flanges	169.00
DOT-FL-21.5"	Round Ladder Deck Flange, pair	33.50
DOT-SL-2	S/S Ladder Deck Flange, pair	48.50

THERAPUETIC LADDERS - STAINLESS STEEL

KDI-42709	2 Tread 1.90 x .065	\$1439.00
KDI-42710	3 Tread 1.90 x .065	1500.00
KDI-42711	4 Tread 1.90 x .065	1573.00
KDI-42712	5 Tread 1.90 x .065	1634.00

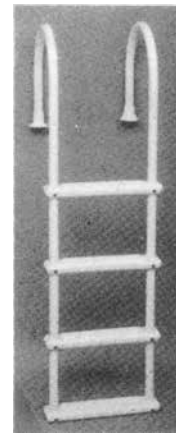

DOT-SPL-4000

FOR OTHER ADA HANDICAP ACCESS, SEE PAGE 35

If Dimension From Deck to Pool Floor is:
 18" to 27" use 2-step
 28" to 37" use 3-step
 38" to 47" use 4-step
 48" to 57" use 5-step

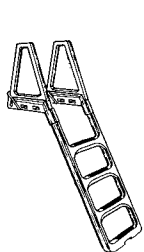

CON-626-B

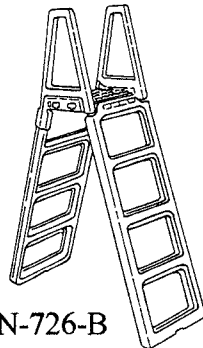

CON-726-B

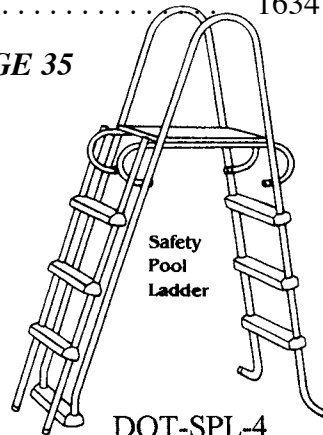

DOT-SPL-4

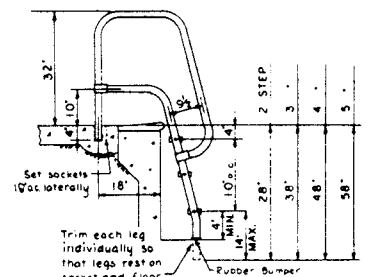

KDI-42710

Ladder Parts & Handrails

LADDERS PARTS

KDI-44101	Paragon HIP Ladder Tread, 18-1/4"	\$ 99.95
KDI-44104	Paragon HIP Chair Tread, sloped, 18-1/4"	99.95
KDI-44107	Paragon HIP Ladder Tread, vertical, 5" x 25-1/4" . .	180.95
KDI-44109	Paragon HIP Tower Tread, sloped, 5" x 25-1/4"	180.95
SRS-LTDF-101	Econoline HIP Tread, 3-3/8" x 19" center line	36.50
SRS-LTDF-103	Elite Tread, Stainless Steel w/ black insert, 3"x 20"	139.95
SRS-LTDF-105	Elite Tread, Stainless Steel, 15 deg.	109.95
SRS-A42073	Frost HIP (Plastic) Tread 3" x 20"	44.95
SRS-A42077	HIP (Plastic) Tread, Blow Molded, 4" x 20"	74.95
SRS-S24701	Saf-T-Tread Step, SQ Towers, 15 deg., 22"	178.50
KDI-LADBO	Stainless Steel Ladder Bolt & Nut, 2- 3/4"	29.50
SRS-A60-702	Stainless Steel Ladder Bolt & Nut for SS Tread	29.95
SRS-A60-704	SS Ladder Bolt & Nut, 3-1/4" for HIP Tread	29.95
SRS-WRB-101A	Rubber Bumper, Female	15.95
SRS-BRB-100EX	XPAND-N-LOC Ladder Bumper (Locks in place)	14.50



SRS-S24701



SRS-A42077

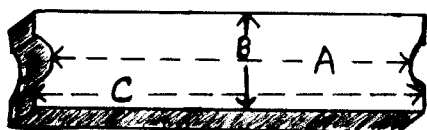

TO MEASURE A LADDER TREAD:
 A = DISTANCE BETWEEN THE RAILS
 B = WIDTH OF THE TREAD
 C = OVERALL LENGTH OF THE TREAD
 D = IS THE TREAD AT AN ANGLE TO THE RAILS OR STRAIGHT?

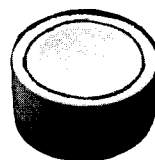

SRS-WRB-101A



PER-PS-4019B

HAND RAILS-STAINLESS STEEL

SRS-2HR-4-049	48" span, 2-bend, 1.90 x .049, 26" drop	\$406.95
SRS-2HR-5-049	60" span, 2-bend, 1.90 x .049, 36" drop	440.95
SRS-2HR-6-049	72" span, 2-bend, 1.90 x .049, 46" drop	469.95
SRS-DMS-101A	Return to Deck Hand Rail, .049	369.50
SRS-F4H-102	Grab Rails-Set of 2, No Anchors	595.95
SRS-SR-100	SPA Rail with S/S Deck Mounting Plate	629.50

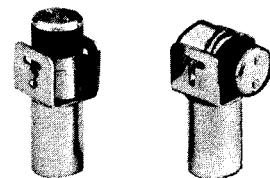

JH-0019-B

HINGED ANCHORS

WEDGE ANCHORS AND ESCUTCHIONS

PER-PS-4019B	Brass Wedge Anchor w/ Wedge, 1.90 O.D. rail	\$ 59.50
PER-PS-4019A	Aluminum Wedge Anchor, 1.90 O.D. rail	21.50
PER-PE-0019S	Stainless Steel Eschuchion, Round	29.95
JH-0019-B	Johnny Ladder Hinge, pair	447.75



SRS-2HR-4-049

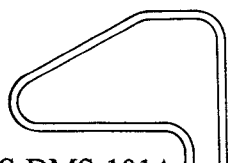

SRS-DMS-101A

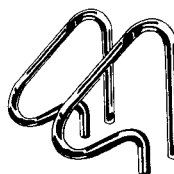

SRS-F4H-102

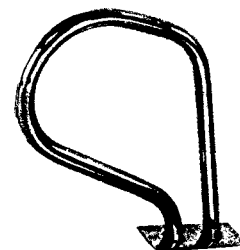

SRS-SR-100

Commercial Boards, Lifeguard Chairs & Slides

FIBERGLASS DIVING BOARDS

(Includes hardware)

SRS-66-209-220	10'x18" Acrylic/Fiberglass, Solid Wood Core . .	\$1799.00
SRS-66-209-222	12'x18" Fiberglass with Solid Wood Core	2250.00
SRS-66-209-224	14'x20" Fiberglass with Solid Wood Core	3895.00
SRS-66-209-226	16'x20" Fiberglass with Solid Wood Core	4195.00

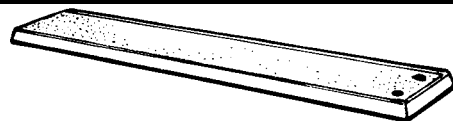

SRS-66-209-222

ALUMINUM DIVING BOARDS

SRS-66-209-310	10' Board with Hardware, 18" wide	\$3295.00
SRS-66-209-312	12' Board with Hardware, 18" wide	3995.95
SRS-66-209-314	14' Board with Hardware, 20" wide	6195.00
SRS-66-209-316	16' Board with Hardware, 20" wide	6750.00

SEE PAGE 16 FOR DIVING BOARD REFINISHING KITS

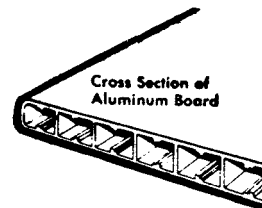

Cross Section of Aluminum Board

DURAFLEX ALUMINUM SPRING BOARDS

DUR-66-231-324	14' Duraflex, 19-5/8" wide	\$6745.00
DUR-66-231-326	16' Duraflex, 19-5/8" wide	7080.00

ASSEMBLIES

SRS-UF-18-101	U Frame, 18" legs-.049 walls	\$ 249.95
SRS-FC-100A	Rubber Fulcrum Pad, Slip On, 20"	73.50
SRS-TDP-100	Tie-down Plate Set.	169.95

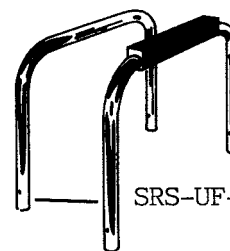

SRS-UF-18-101

LIFEGUARD CHAIRS AND UMBRELLAS

KDI-20621	Standard Lifeguard Chair-Stainless Steel	\$3250.00
KDI-20002	Superflyte Lifeguard Chair with rear ladder . .	4995.00
KDI-20302	6' Moveable Lifeguard Chair	6650.00
KDI-20301	8' Moveable Lifeguard Chair	6995.00
RS-91650	Umbrella, Multi-Color, 6 ft. spread with tilting device and 7 ft. pole.	134.95
RS-2070110	Replacement Fiberglass Seat, Swimquip, Paddock, Paragon, etc. (specify bolt pattern)	269.95
REC-42637	Replacement Lifeguard Seat, no holes	214.95
RS-836FT-50	Solar Coated Umbrella – Reflects the sun!	87.95



RS-91650

RESIDENTIAL SLIDES (Commercial - call for quotes)

(Minimum of 4- 1/2' water required) White/ Blue

SRS-610-209-58	8' Right/Left-hand curve slide	\$3150.00
PM-36631	Slide Spray Repair Kit (tubing & fittings)	49.95
PM-36630	Slide Spray Tubing only (12').	21.50



KDI-20002

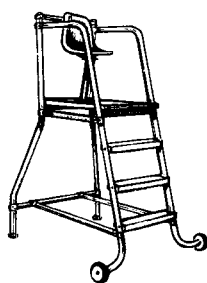

KDI-20302



SRS-610-209-58



KDI-20621

Handicap Access & Lifts

There are many types of ramps, steps, ladders and chair lifts available for use in above-ground and in-ground pools, as well as spas. CALL US for specific details on these or other products.

AQUATREK² RAMP Thermoplastic 3-IN-ONE System
 AQ-9000 Stair, ramp, underwater parallel bars \$9723.00

AQUATREK² STEP Noncorrosive, lightweight, portable plastic
 AQ-7000 7-Step Model \$6534.00

AQUATREK² STEP SYSTEM (ADA APPROVED)
 SADA-4 4-Step Model \$6049.00

POOL LIFTS with anchor (ADA Approved)

F-409RPL-C	Ranger2 Pool Lift, 350# lift.	\$4950.00
F-004PLB	Pro Pool Lift, 450# lift.	6195.00
IGAT-180	Automatic 180 turn, 400# lift at 55psi	6450.00
SRS-575	Multi-Lift, 350# lift	5955.00
SRS-AXS100	aXs Lift, 360 turn, 300# lift.	6300.00
SRS-300	Splash! Aquatic Lift System, 400# lift	9155.00
SRS-200	PAL2 Portable Aquatic Lift, 300# lift	10995.00

SPA LIFTS (Call for product information and pricing)

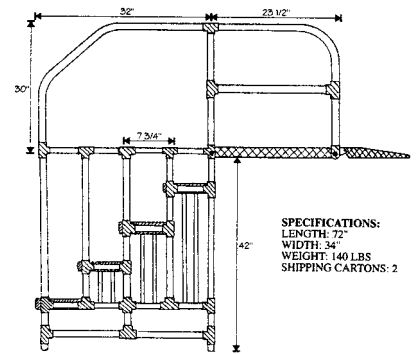
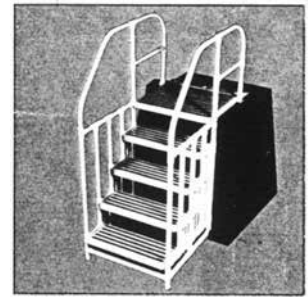

AQUATREK LADDER



POOL LIFT SRS-575



POOL LIFT SRS-AXS100



POOL LIFT SRS-300



POOL LIFT SRS-200

AQUATREK STEP

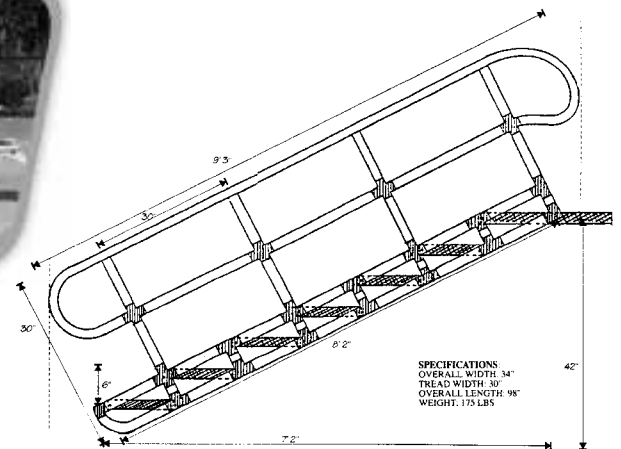

Commercial Pool Equipment

LIFEGUARD ACCESSORIES

REC-12350	Sew-on "GUARD" patch, Red Letters	\$ 5.00
RS-64100-65	Whistle, Acme, Black Plastic	5.95
RS-118R	Lanyard Only	2.45
REC-12354	Whistle Tip Guard	1.85

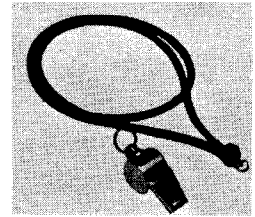

WHISTLE AND LANYARD

EXERCISE, TRAINING & RACING ACCESSORIES

PM-50513	Deluxe Swim Board, Solid Foam, 11.5"x18" \$	26.95
PM-50515	Polyform Swim Board w/handles, 12"x27" . .	28.50
SWIMCORDS	Exercise Ankle Tether	44.75
SUPERSWIM	Exercise Tether.	481.95
RS-54200	Official Dive Brick, 10#	73.95
REC-14330	75' Competitor Racing Lane Line, 4"	485.00
REC-14331	25 Meter Competitor Racing Lane Line, 4" . .	529.75
REC-14360	Fiberglass Lane Line Storage Reel	2395.00



REC-80220

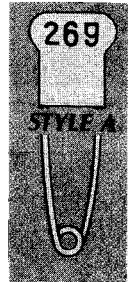

SHOWER CURTAINS — Heavy-duty vinyl-coated nylon.

Finished edges on all 4 sides. Grommets every 6".

Sizes available from 3'-6" wide to 6'-9" long.

REC-77455 Shower Curtains CALL FOR QUOTES

CHECK PINS & TAGS, WRIST BANDS, CHECK BAGS

REC-80280	100 Style A, Plain Brass Check Pins	\$ 169.50
REC-80250	100 Style A, Numbered Brass Check Pins . . .	214.95
REC-80320	100 Style A, Plain SS Check Pins	194.95
REC-80502	100 Numbered Brass/Colored Aluminum Tags	99.95
REC-80350	100 Elastic Wrist Bands	165.50
REC-80370	21"x18" Standard Check Bag	34.95

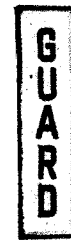

REC-12350



REC-80350

BASKETS — Zinc Plated w/ aluminum number plate.

Specify number sequence or plain.

REC-80210	9" x 13" x 8" Basket	\$ 42.50
REC-80220	12" x 13" x 8" Basket	39.95

BASKET AND CHECK BAG RACKS CALL FOR QUOTE

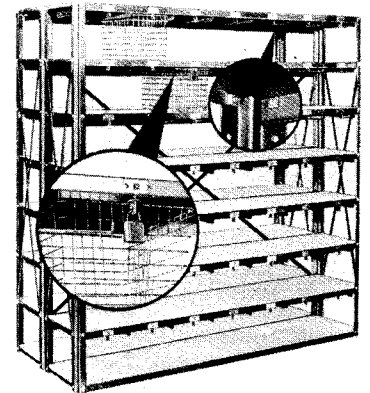

FLOORING

REC-77880	DriDeck Tile, 12" x 12", Pack of 12	\$ 89.50
REC-77886	DriDeck Roll, 3' x 12'	299.00

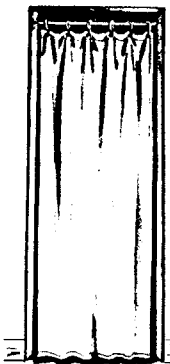

SHOWER CURTAINS



OFFICIAL 10 LB. DIVING BRICK

REC-80502

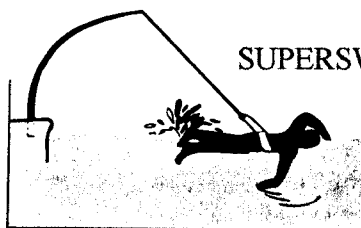
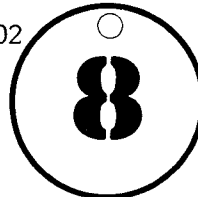

SUPERSWIM

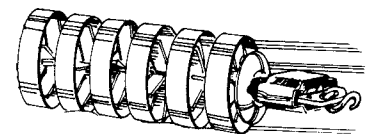

REC-14330

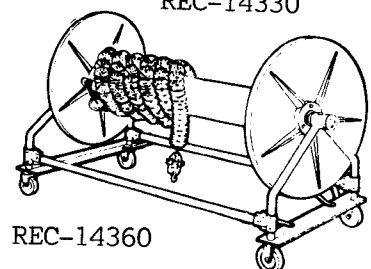

REC-14360

Signs

NOW AVAILABLE - Signs with 4" lettering. Call for info!

PM-40314	Boys, 12 x 3	\$ 5.50
PM-40315	Girls, 12 x 3	5.50
PM-40319	Pool Reserved for Tenants Only, 18 x 12	14.95
PM-40320	Please Shower, 18 x 12	14.95
PM-40323	Warning No Lifeguard, Red/Black/White, 18 x 24	18.95
PM-40325	No Lifeguard, Red/White/Blue, 24 x 18	18.95
PM-40326	Pool Rules/Hours, 18 x 24	18.95
PM-40327	Spa Rules, 18 x 24	18.95
PM-40333	Pool Closed, 18 x 12	14.95
PM-40339	Emergency Phone Numbers, 18 x 12	14.95
PM-40360	Caution: Spa Users: Precautions, 18 x 12	14.95
PM-40365	Attention Spa Users: Health Risks, 18 x 12	14.95
PM-40366	Saving a Life and Emergency, 18 x 24	18.95
PM-40368	Pool Rules, Public or City, 18 x 24	18.95
PM-41327	We Don't Swim in Your Toilet, 12 x 18	14.95
PM-41330	Alright Who Peed in the Pool, 12 x 18	14.95
PM-41332	No Glassware in Pool Area, 12 x 6	11.50
PM-41334	We Don't Swim in Your Toilet, 12 x 18	14.95
PM-41340	God Bless Our Pool, Our Only Liquid Asset, 12 x 6	11.50
PM-41343	God Bless Our Spa, Our Only Liquid Asset, 12 x 6	11.50
PM-41350	Warning: Urine Detector, 12 x 18	14.95
PM-41352	Welcome to our OOL (Notice no "P"), 12 x 18	14.95
PM-41370	Above Ground Pool Rules, 12 x 18	14.95
PM-41373	Don't Pee in our Spa, 12 x 18	14.95
RS-1309	No Lifeguard (Nebraska)	59.50
RS-1750	Authorized Personnel Only, 15 x 19	9.50
RS-1850	No Running, 18 x 12	17.50
RS-1950	Pool Capacity, 18 x 12	17.50
RS-2050	Watch Your Children, 12 x 18	17.50
RS-6802	No Food or Beverage in Pool Area, 18 x 12	29.50
RS-202450	Nebraska Pool Regulations	99.95
RS-3024E50	Nebraska Spa Regulations with Capacity	108.00
RS-SW-2050	Caution--No Diving, 12 x 18	17.50



RS-1850



PM-40319

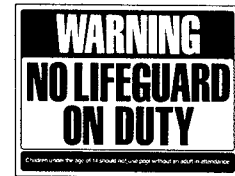

PM-40325



PM-41350



RS-2050

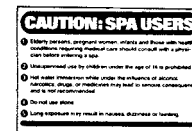

PM-40360



PM-41370



PM-41352



PM-41330



PM-41327



PMC-41343



PM-40326

Replacement Cartridge Filters

COMMON CARTRIDGE FILTER REPLACEMENTS

There are hundreds of different filter sizes. Here are some common ones. The model name or number of your spa or filter housing can be helpful in determining filter size.

		O.D.	I.D.	HEIGHT	
HS-20204	Grandee	8-1/2"	3" x FPT	10-1/4"	\$ 98.00
HS-31114	Clas/Sov/TR	8-1/2"	3"	10-1/4"	80.00
HS-31115	CI/Prod/Jet	6-1/4"	3"	12"	62.00
HS-31489	1991 to present	6"	1-7/8"	10-1/2"	45.00
HS-33521	Hot Spot	4-7/8"	2-1/8"	13-1/4"	45.00
HS-73178	TRI-X	6"	1-7/8"	10-1/2"	85.00
HS-1019301	Mallorca	7"	T: closed;B:2-5/8"	15"	85.95
UNI-UHD-SR50	TX-50	8-11/16"	4-3/16"	13-5/16"	89.00
UNI-UHD-SR70	TX-70	8-11/16"	4-3/16"	18-3/16"	110.00
UNI-UHD-SR100	TX-100	8-11/16"	4-3/16"	25-11/16"	145.00
UNI-C-4325	C-225RE	4-5/8"	2-1/16"	11-1/4"	46.00
UNI-C-7626	C-250RE	7"	3"	9-13/16"	58.00
UNI-C-7656	C-500RE	7"	3"	19-5/8"	82.00
UNI-C-8600	C-800RE	8-1/2"	4-1/16"	17-1/2"	115.00
UNI-4CH-30	Various	4-5/8"	T:handle;B:1.5" MPT	11-7/8"	55.00
UNI-C-2606	Pac-Fab	2-7/8"	1-1/16"	9-3/4"	24.00
UNI-C-4305	Cal Spa	4-15/16"	2-1/8"	14-7/8"	58.00
UNI-C-4405	DSF-50 Rain	4-15/16"	2-1/8"	6-5/8"	70.00
UNI-C-4605	Muskin	4-1/2"	2-3/16"	8"	22.00
UNI-C-4625	25sqft. Rain	4-15/16"	2-1/8"	13-5/16"	50.00
UNI-C-4950	50sqft. Rain	4-15/16"	2-1/8"	13-5/16"	65.00
UNI-C-5625	Jacuz, Sonoma	5"	2-3/8"	13-5/16"	49.00
UNI-C-5626	Pac.Marquis	5-3/16"	T:1-1/16"; B:1-5/8"	11-7/8"	55.00
UNI-C-6300/no core	Jacuz	6-7/8"	3-1/2"	14-7/8"	56.00
UNI-C-7466	Sundance	7-1/2"	T:closed; B:2-5/8"	14-3/4"	89.00

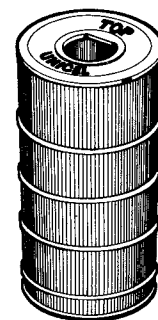
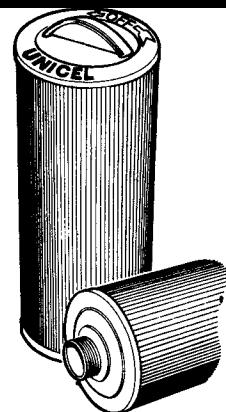

(set of 2)

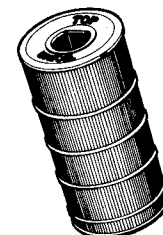

HOW TO MEASURE FOR A NEW REPLACEMENT FILTER

1. Measure OUTSIDE DIAMETER (O.D.)
2. Measure overall HEIGHT
3. Measure INSIDE hole DIAMETER (I.D.)

Note: Top and Bottom holes may be different!

Also, some holes are closed, have a handle or have a male pipe thread (MPT).

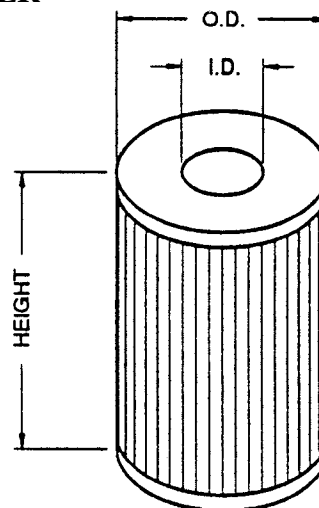

6", 7" and 8" Top



4-5/8" Top



MPT Bottom
1-1/2" and 2"

Spa Care

CHLORINATING CONCENTRATE

		Granular Dichlor.	
BG-42612	14 oz. Bottle	\$20.50
BG-42614	2# Bottle	32.99
BG-42616	5# Bottle	72.99

BROMINATING CONCENTRATE

One step granular. Establishes Bromide Bank.

BG-42602	14 oz. Bottle	\$22.50
BG-42604	2# Bottle	39.99
BG-42606	6# Bottle	92.50

BROMINE TABLETS

For Floaters.

BG-42608	1.5# Bottle	\$40.50
BG-42610	4.5# Bottle	94.99

SPA SHOCK

Buffered, Non-chlorine Shock.

BG-42624	35 oz. Bottle	\$31.99
----------	---------------	-------	---------

ENHANCED SHOCK

Includes clarifiers.

BG-42621	2# Bottle	\$29.99
BG-42622	6# Bottle	59.99

pH INCREASER

Raises pH.

BG-42632	18 oz. Bottle	\$15.50
----------	---------------	-------	---------

pH DECREASER

Lowers pH.

BG-42634	22 oz. Bottle	\$15.50
----------	---------------	-------	---------

STAIN & SCALE CONTROL

For metals & calcium.

BG-42642	Pint	\$23.99
BG-42644	Quart	37.50

CALCIUM HARDNESS INCREASER

BG-42636	12 oz. Bottle	\$13.95
----------	---------------	-------	---------

TOTAL ALKALINITY INCREASER

BG-42630	2# Bottle	\$20.75
----------	-----------	-------	---------



ANTIFOAM

Stops foaming instantly.

BG-42646	Pint	\$19.99
BG-23642	Quart	29.50

WATER CLARIFIER

Stops cloudiness.

BG-42648	Pint	\$16.99
----------	------	-------	---------

OFF THE WALL SURFACE CLEANER

Cuts grime.

BG-23613	Pint	\$12.50
----------	------	-------	---------

NATURAL SPA ENZYME

Digests oily buildup.

BG-42652	Quart	\$28.99
----------	-------	-------	---------

FRESHENER & DEODORIZER

Fresh scent.

BG-42656	Pint	\$21.99
----------	------	-------	---------

FILTER CLEANER/DEGREASER

Spray.

BG-42654	Quart	\$21.99
----------	-------	-------	---------

STRIP KWIK

Filter Degreaser.

BG-23756	Quart	\$23.00
----------	-------	-------	---------

KLEEN-IT

Filter Descaler.

BG-23758	Quart	\$24.99
----------	-------	-------	---------

TEST STRIPS

5 tests in-one strip.

BG-26344	Bottle of 50 strips	\$22.50
----------	---------------------	-------	---------

SPA SYSTEM FLUSH

BG-42650	24 oz. Bottle	\$18.50
----------	---------------	-------	---------

Spa Accessories & Maintenance

FIX-A-LEAK	Liquid Leak Repair	\$ 49.50
HS-60623	Rubber Duck. A MUST for any spa!!!	5.50
HS-71515	Spa Top Coverlock-Black (set of 4)	20.00
HS-71530	"Spa Vac" Thumb-control vacuum	49.95
HS-72602	Ozonator for Hot Springs Spas F-W III	395.00
HS-73071	Lift 'N Glide Cover Lifter	225.00
HS-74346	Water Vac. Hooks up to garden hose	39.50
HS-77139	Ace System Cell Cleaner	15.95
HS-80000	Freshwater Salt, 10# Bag	31.95
HS-80004	Freshwater Salt Cartridges, 3/pkg.	284.95
HS-80010	Silver Ion Sanitizer-no bromine alternative.	40.50
HS-80101	Calcium Removal Pillow	71.95
HS-80105	Cover Shield Spa Top Treatment.	15.00
NC-04137	Spa Purge Line Cleaner	22.75
PS-084	Floating Thermometer	19.95
PS-219	Floating Brominator.	27.50
SEN-SB-2	Scumball Absorbs spa oils	19.95
SPASCENT	Flavorful variety of scents in a bottle	12.95
SUN-HDS	Cover Hold-down straps, pair	54.50

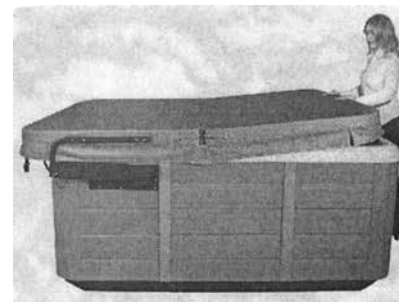

Lift 'N Glide Cover Lifter
HS-73071



HS-60623

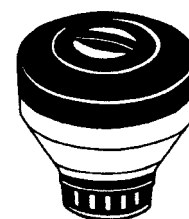

PS-219

STEPS AND HANDRAILS

Polymer, Double Step, Gray, Espresso, Charcoal, Teak, Redwood	\$200.00
Everwood/Surewood, Double Step, Gray, Espresso, Teak	395.00
HS-76023 Handrail with Light	279.95

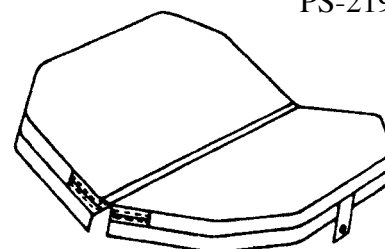

SPA TOPS

SPA COVERS APPROXIMATELY \$530.00
CALL FOR QUOTE



HotSpring®

Every day made better®



6 KEYS TO SPA CARE



1. CIRCULATION:

The pump moves water through the filter so particles are trapped and removed. Circulation also distributes chemicals throughout the water to kill harmful bacteria.

2. FILTRATION:

Keep Filters Clean!!! They do an abundance of work to keep your spa water clean. It is very important to clean your cartridge filters regularly. Skin oils build up on them and/or scale forms on them. On Hot Spring models, the filter dedicated to continual filtration will tend to get dirty quicker than the others. The water flow is then reduced. Decreased flow trips the heater reset button. (This is a Hot Spring safety feature to prevent the heater from over-heating because of the low flow.) Every 4-6 weeks remove your filters and hose them off with a garden hose with an end-nozzle attached. Spray on **FILTER CLEANER** to help loosen the built-up oils and dirt. Rinse thoroughly!!! Let dry. Replace. We recommend that you use **STRIP KWIK** and **KLEEN IT** 2-3 times a year to do a more intensive, thorough cleaning. (We will gladly do this for you---bring your dirty filters by the store.) A good technique for keeping filters clean is to have an extra set. That way while one set is removed for cleaning the other set is clean, dry and ready to use.

3. CLEANING:

Remove obvious dirt by using a spa vac. Clean the water line with **OFF THE WALL SURFACE CLEANER**. (Other products are not compatible with spa water chemistry.) Also, use **NATURAL SPA ENZYME** weekly to keep oils from accumulating. The spa will be less likely to foam, the surface and waterline will stay cleaner longer, and the filter life will be extended.

4. DRAINING AND REFILLING:

Replace the water in your spa regularly. How often???? When water goes “dead” or use this formula:
Spa Gallons / Daily Bathers / 3 = days between draining.

Use **SYSTEM FLUSH** prior to draining, cleaning, and refilling your spa. This will remove unseen build-up in the plumbing that can impact performance. Before draining, first shut off power. After emptying the tub, clean all surfaces with **OFF THE WALL SURFACE CLEANER**. Rinse well. Refill the tub by putting the hose in the filter compartment. This will minimize air entrapment in the lines. Once the tub is filled, on 220V Hot Spring models, turn on the 20 amp breaker first and run the jets for 5 minutes before turning on the 30 amp breaker. This will prevent the heater from air locking and kicking the heater reset. On 110V models, run the jets as soon as the power is reconnected to prevent the air locks.

5. CHEMICALS:

Use **STAIN AND SCALE CONTROL** as tub is filling to prevent stains and to control metals. Add **WATER CLARIFIER** and let circulate. Use **CHLORINATING CONCENTRATE** or **BROMINATING CONCENTRATE** to establish a sanitizer residual. Keep your water sanitized at all times. Use **BROMINATING TABLETS** in a floater. Add **SOFT SOAK TRIO** to make your water feel soft and smooth. Shock with **ENHANCED SHOCK** weekly or as spa usage dictates. Maintain proper pH. This is important both for spa user comfort, as well as equipment longevity and proper sanitizer control. Use **pH INCREASER** to raise a low pH (below 7.4). Use **pH DECREASER** to lower a high pH (above 7.6). Use **STAIN & SCALE CONTROL, WATER CLARIFIER** and **NATURAL SPA ENZYME** weekly for regular care.

6. TESTING:

Regularly check your pH and sanitizer level. **ALWAYS HAVE A SANITIZER READING BEFORE ENTERING THE SPA!!!** We can do a source water analysis and assist you in selecting a chemical maintenance system that is easiest for you to use.

We are here to make your **WATER FUN!!!**

Arnold Pool Company

1801 Stagecoach Trail
Ogallala, NE 69153

PRSR STD
U.S. Postage
PAID
Ogallala, NE
Permit No. 10

